

Form 20328
Rev. (451)

INSTRUCTIONS
FOR USING
SINGER
ELECTRIC SEWING MACHINE
(P. G. Built-on Motor)
15-91
REVERSIBLE FEED
LOCK STITCH, FOR FAMILY USE

WHEN REQUIRING
NEEDLES, OIL,
PARTS OR
REPAIRS FOR
YOUR MACHINE



LOOK FOR THE
RED "S"
THERE ARE
SINGER SHOPS IN
EVERY CITY

THE SINGER MANUFACTURING COMPANY

Printed in U. S. A.

Use **SINGER*** SEWING MACHINE
OIL on Machine

Knowing from many years' experience the great importance of using good oil, **SINGER** sells an extra quality sewing machine oil, in cans, especially prepared for sewing machines.

Use **SINGER*** MOTOR LUBRICANT
on Motor

The **SINGER** MOTOR LUBRICANT is especially prepared for lubricating the bearings of the electric motor. This is a pure non-flowing compound which retains its consistency and possesses high lubricating qualities.

INSTRUCTIONS
FOR USING
SINGER*
ELECTRIC SEWING MACHINE
(P. G. Built-on Motor)
15-91
REVERSIBLE FEED
LOCK STITCH, FOR FAMILY USE



MACHINE 15-91

*A TRADE MARK OF
THE SINGER MANUFACTURING COMPANY

TO ALL WHOM IT MAY CONCERN:

The improper placing or renewal of the Trade Mark "SINGER" or any other of the Trade Marks of The Singer Manufacturing Company (all of which are duly Registered Trade Marks) on any machine that has been repaired, rebuilt, reconditioned, or altered in any way whatsoever outside a SINGER factory or an authorized SINGER agency is forbidden.

SINGER Needles should be used
in SINGER Machines.
These Needles and their Containers
are marked with the
Company's Trade Mark "SIMANCO.*" 1

Needles in Containers marked
"FOR SINGER MACHINES"
are NOT **SINGER** made needles. 2

SINGER SERVICE

Now that you have purchased your new SINGER, we do not want you to feel that your relations with us have come to an end. You are cordially invited to visit your SINGER Shop at any time for assistance in your sewing problems. You will be most welcome.

We hope, too, that you will make the SINGER Shop your headquarters for sewing supplies and service. Only there or through authorized bonded SINGER representatives can you secure warranted SINGER SEWING MACHINE OIL, needles, belts, parts, etc., so important in getting the best results from your machine. And remember, only an authorized SINGER representative should be allowed to touch your machine when repairs or adjustments are required.

World-wide SINGER SERVICE has no equal.
Use it!

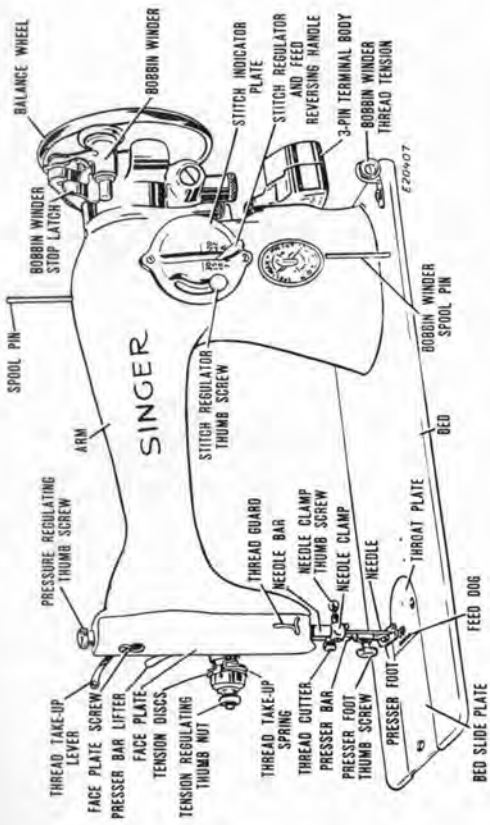

FIG. 2

NAMES OF PRINCIPAL PARTS OF MACHINES 15-91

DESCRIPTION

This SINGER family sewing machine will give you practically life-time service.

It is intended for operation by electricity, having an electric motor built on the back of its arm. The motor drives the machine through spiral gears.

It is also equipped with an electric SINGER-LIGHT*.

The machine has an oscillating shuttle on a horizontal axis and makes the lock stitch. It has reverse feeding mechanism which enables you to sew either in a forward or backward direction, making it easy to back tack and to fasten the ends of seams.

In addition to plain sewing, a great variety of pleasing effects such as hemming, binding, edge stitching, shirring, ruffling, etc., can be produced with the aid of the attachments furnished with the machine. These attachments and other popular SINGER Fashion Aids will enable you to obtain the much desired tailored appearance of professionally-made garments and to add new fashion touches or finishes demanded by swiftly changing styles at a fraction of the cost of ready-made garments.

**READ THIS BOOK CAREFULLY TO GET
THE UTMOST SERVICE
FROM YOUR SEWING MACHINE**

ELECTRICAL INFORMATION

Motor

The SINGER electric motor, located at the back of the machine, is regularly furnished for operation on a direct current of 110-120 volts or on alternating current of 110-120 volts, 25 to 75 cycles. Special motors can be furnished for direct or alternating current for any voltage between 50 and 250, and for 32 volts direct current.

To Connect Machine to Electric Service Line

Before connecting the machine to the electric service line, be sure that the voltage and the number of cycles stamped on the motor nameplate are within the range marked on the electric meter installed by the electric power company.

Push the terminal plug at one end of the electric cord on the three-pin terminal block (see Fig. 2, page 4) at the right of the machine and connect the plug at the other end of the cord to an electric outlet.

CAUTION

When you have finished your sewing, always disconnect the plug from the electric outlet.

SINGERLIGHT

The SINGERLIGHT is turned "on" or "off" by the switch **A**, Fig. 3.

To Remove the Bulb

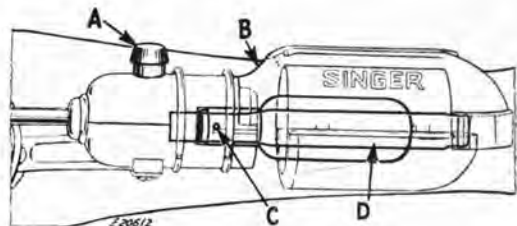

FIG. 3. REPLACING THE BULB

Grasp the SINGERLIGHT socket so that the thumb extends over the switch **A**.

Press the shade with the thumb at **B** to release the shade from the two catches and slide it **half-way out** of the shade holder **D**.

Do Not Attempt to Unscrew the Bulb. It is of the bayonet and socket type and does not unscrew. **Press the Bulb Into the Socket** and at the same time turn the bulb over from the machine as far as it will go, then withdraw the bulb.

To Replace the Bulb

Hold the socket with one hand and at the same time with the other hand press the new bulb into the socket and turn it over toward the machine until the bulb pin **C**, Fig. 3 enters the notch in the socket.

Return the shade to its normal position, as shown in Fig. 3.

TO OPERATE THE MACHINE

Raise the presser foot **B** by means of the presser bar lifter **C** to prevent injury to the foot **B** and feed **A**.

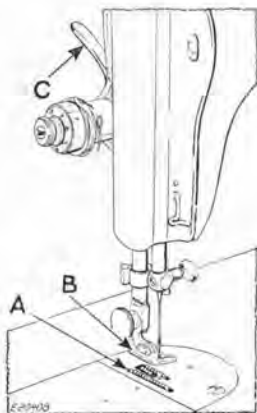

FIG. 4. FRONT VIEW OF THE MACHINE

Place a piece of cloth under the presser foot and let the foot down upon it.

Turn on the electric current and, if the combination knee and foot controller is installed as a knee controller, press the controller to the right, or, if the controller is placed on the floor to be used as a foot controller, press down on the pedal of the controller. As the pressure on the controller is increased, the speed of the machine is increased, the speed being controlled entirely by the amount of pressure on the controller. Operate the machine in this way, without being threaded, until you have become accustomed to guiding the material and operating the controller.

NEEDLES AND THREADS

For perfect stitching, the **thread** should be selected according to the fabric to be stitched and the **needle** must be the correct size for the thread which must pass freely through the eye of the needle.

CHART SHOWING THE RELATIONSHIP OF TYPES OF FABRICS, THREAD AND NEEDLE SIZES AND MACHINE STITCHES TO THE INCH

TYPES OF FABRICS	THREAD SIZES	NEEDLE SIZES	MACHINE STITCHES PER INCH	
			INSIDE SEAMS	TOP STITCHING
Filmy materials comparable to Net, Marquisette, Organdie, Ninon.	100 Cotton OO and OOO Silk	9	20	30
Sheer materials comparable to Lawn, Dimity, Voile, Batiste, Chiffon, Rayon, Sheer, Rayon Crepe.	80 to 100 Cotton O Silk	11	16	20
Lightweight materials comparable to Gingham, Chambray, Sheer Wool Crepe, Taffeta.	60 to 80 Cotton A and B Silk	14	12	18
Medium lightweight materials comparable to Poplin, Pique, Pereaie, Cretonne, Chintz, Faille, Bengaline, Wool Flannel, Wool Crepe, Wool Jersey.	50 to 70 Cotton B Silk	14	12	16
Medium heavy materials comparable to Crash, Gabardine, Rep, Corduroy, Velveteen.	40 to 50 Cotton C Silk	16	10	12
Heavy materials comparable to Sailcloth, Denim, Ticking.	30 to 40 Cotton 24 to 30 Cotton D Silk	18 19 18 or 19	8	10
Very heavy materials comparable to overcoating.	40 to 60 Linen 20 to 24 Cotton E Silk	21	6	8
Plastic materials.	Mercerized Cotton	11	10	12

When ordering needles, always specify "Class and Variety 15x1" and state the size and quantity required.

TO SET THE NEEDLE

Select the correct needle according to the table on **page 9**. Be sure that the needle is not blunt or bent. Raise the needle bar to its highest position and loosen the thumb screw **K** in the needle clamp. Push the needle **with its flat side to the left** up into the needle clamp as far as it will go, then tighten the thumb screw.

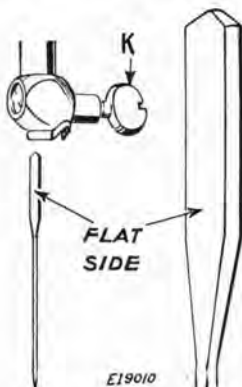

FIG. 5. SETTING THE NEEDLE.

UPPER THREADING

(SEE FIG. 6 ON THE FOLLOWING PAGE)

- Raise the take-up lever **5** to its highest point.
- Place the spool of thread on spool pin at top of machine
- Pass the thread through the thread guide **1**
- Down, under and from back to front between the tension discs **2** (the thread guard **L** guiding the thread between the discs)
- Hold the spool tightly and pull the thread against the take-up spring **4** until it enters the retaining fork **3**
- Pass the thread from back to front through the hole **5** in the take-up lever
- Down through the guide **6** on the face plate
- Into the guide **7** on the needle clamp
- From **right** to **left** through the eye **8** of the needle.
- Draw about two inches of thread through the eye of the needle with which to commence sewing.

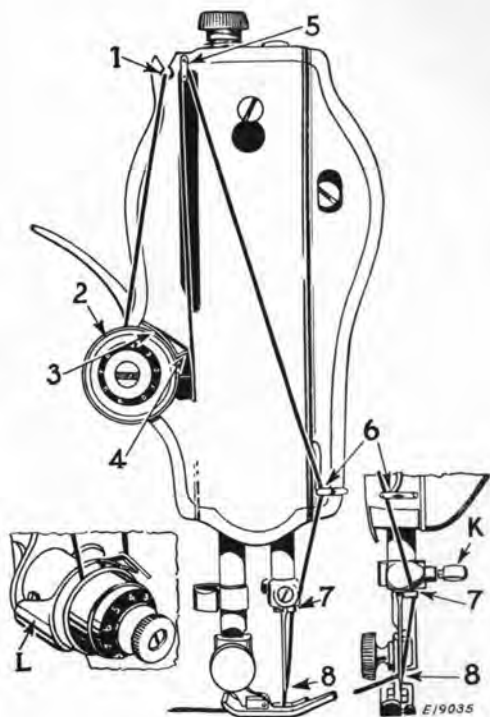

FIG. 6. UPPER THREADING

TO REMOVE THE BOBBIN

Raise the take-up lever **5**, **Fig. 6** to its highest point. Withdraw the bed slide plate. Reach down with the left hand and open the bobbin case latch **M**, **Fig. 7** and lift out the bobbin case. Release the latch and remove the bobbin from the bobbin case.

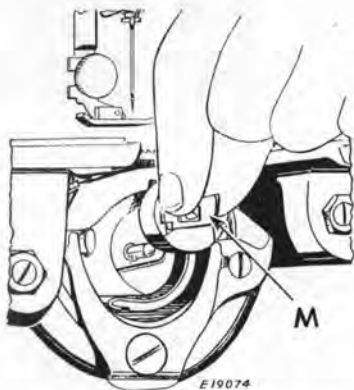

FIG. 7. REMOVING THE BOBBIN CASE

TO WIND THE BOBBIN

(SEE FIG. 8 ON THE FOLLOWING PAGE)

Hold the balance wheel **D** with the left hand and, with the right hand, loosen the stop motion screw **E** to release the balance wheel from the stitching mechanism.

Place the bobbin on the bobbin winder spindle as far as it will go, having the small pin enter the hole in the side of the bobbin.

- Place the spool of thread on the spool pin **1**
 Pass the thread to the right between the tension discs **2**
 Up and to the left through the hole in the left side of the bobbin **3**, from the inside.

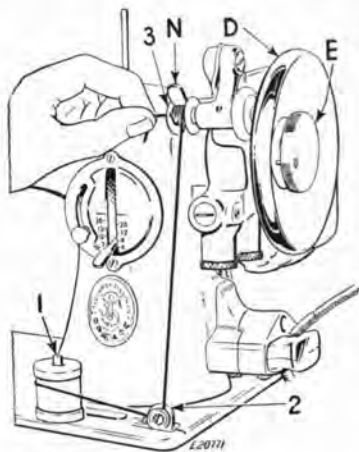

FIG. 8. WINDING THE BOBBIN

The end of the thread must be held by the hand until a few coils are wound and then should be broken off.

Press down on the bobbin and the bobbin winder latch will drop down and hold the bobbin winder pulley against the hub of the balance wheel.

Then operate the machine the same as for sewing. When sufficient thread has been wound upon the bobbin, the bobbin winder is automatically released from the balance wheel.

Then tighten the stop motion screw **E**.

If the pressure of the bobbin winder pulley against the hub of the balance wheel is insufficient for winding the bobbin, press down the bobbin winder until the latch **N**, **Fig. 9** drops down and holds it, then loosen the adjusting screw **O**, **Fig. 9**. With the forefinger, push back the upper end of the slotted plate **P** as far as it will go, as shown in **Fig. 9**, and at the same time press the bobbin winder pulley against the hub of the balance wheel, then tighten the adjusting screw **O**.

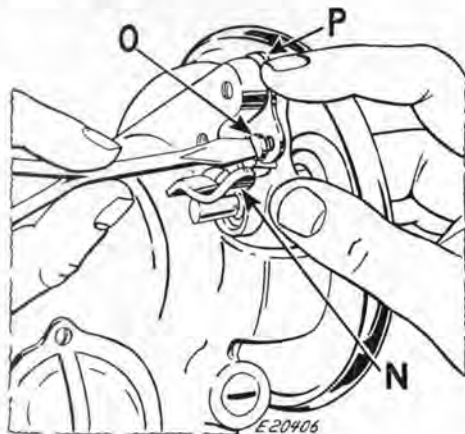

FIG. 9. ADJUSTMENT OF BOBBIN WINDER

If the thread does not wind evenly on the bobbin, loosen the screw which holds the tension bracket **2**, **Fig. 8** in position on the bed of the machine and slide the tension bracket to the right or left, as may be required, then tighten the screw.

Bobbins can also be wound while the machine is sewing.

TO THREAD THE BOBBIN CASE

Hold the bobbin so that the thread will unwind in the direction shown in Fig. 10.

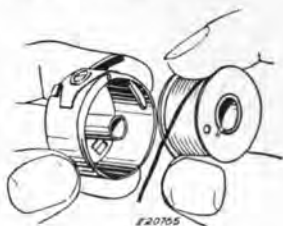

FIG. 10

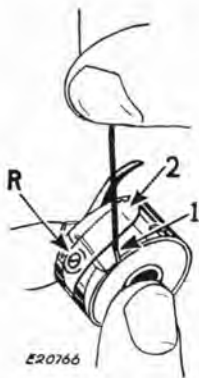

FIG. 11

Hold the bobbin case as shown in Fig. 10, and place the bobbin into it.

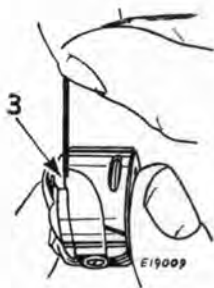

FIG. 12

Pull the thread into the slot 1, under the tension spring 2 and into the slot 3 at the end of the spring.

TO REPLACE THE BOBBIN CASE

Hold the bobbin case by the latch and place it on the stud **T** of the shuttle body with the position finger **S** opposite the notch at the top of the shuttle race.

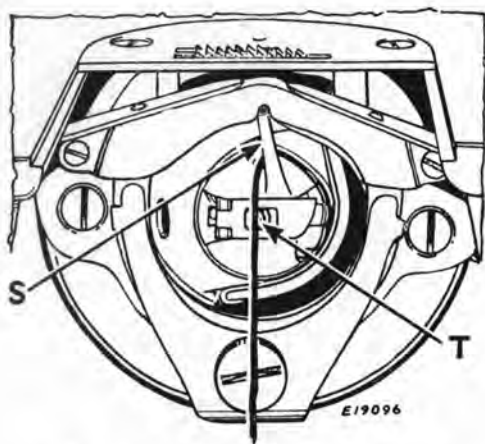

FIG. 13. BOBBIN CASE THREADED AND REPLACED

Release the latch and press the bobbin case back until the latch enters the groove in the stud. Allow about three inches of thread to hang free from the bobbin case and close the bed slide plate.

TO PREPARE FOR SEWING

Hold the end of the needle thread with the left hand and turn the balance wheel over toward you until the needle goes down and up again and the thread take-up lever **5**, **Fig. 16** is at its highest point. Pull up the needle thread and bobbin thread will come with it, as shown in **Fig. 14**.

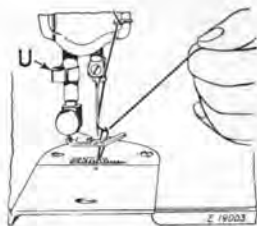

FIG. 14

DRAWING UP THE BOBBIN
THREAD

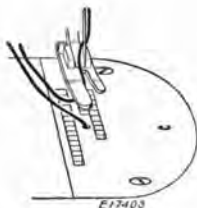

FIG. 15

THREADS IN POSITION TO
COMMENCE SEWING

Lay both threads back under the presser foot diagonally across the feed, as shown in **Fig. 15**, to the right or left, depending upon which side of the needle the material is to be located, so that when the presser foot is lowered, the threads will be firmly held between the feed and the presser foot.

TO COMMENCE SEWING

Be sure to have the thread take-up lever 5 at its highest point.

Place the material beneath the presser foot **B**, lower the foot by means of the presser bar lifter **C** and commence to sew, turning the balance wheel over toward you.

Never pull the material along when stitching. This is liable to bend the needle. Guide the material only.

Never operate the machine without cloth under presser foot.

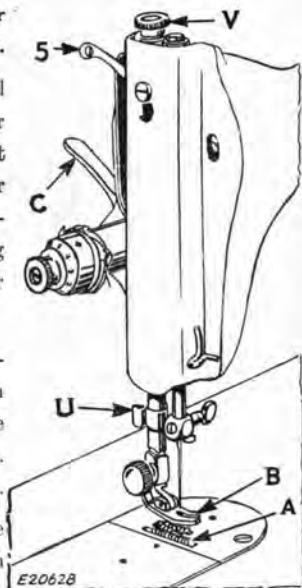

FIG. 16

The slide over the bobbin case should be kept closed when the machine is in operation.

The balance wheel must always turn over toward the operator.

TO TURN A CORNER

Stop the machine when the needle is commencing its upward stroke. Raise the presser foot and turn the work as desired, using the needle as a pivot, then lower the presser foot.

BASTING

Adjust the stitch regulator **X**, **Fig. 17** to make the longest stitch and loosen the needle thread tension **A**, **Fig. 21**, so that the stitches may be easily removed.

Machine basting is firmer, more even and much quicker than hand basting.

TO SEW FLANNEL OR BIAS SEAMS

Use a short stitch and as light tension as possible on the needle thread so as to leave the thread loose enough in the seam to allow the material to stretch if necessary.

TO REMOVE THE WORK

Stop the machine with the thread take-up lever **5**, **Fig. 16** at its highest position. Raise the presser foot, draw the fabric back and to the left, and sever the threads on the thread cutter **U**, **Fig. 16**. Place the ends of the threads under the presser foot, as shown in **Fig. 15**.

TO REGULATE THE LENGTH OF STITCH

The machine is adjustable to make from 6 to 30 stitches per inch, as indicated by the numerals on the stitch indicator plate **W**.

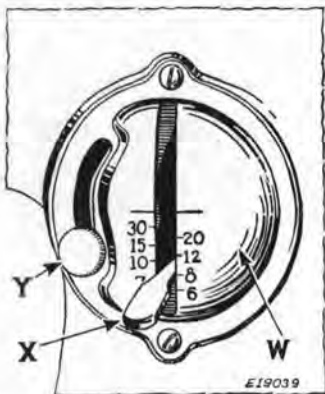

FIG. 17. SHOWING LEVER FOR REVERSING DIRECTION OF FEED AND REGULATING LENGTH OF STITCH

The number of stitches to the inch that the machine is set to make is indicated by the number which is in line with the upper side of the stitch regulating lever **X**.

To change the length of stitch, loosen the thumb screw **Y** and move it to the bottom of the slot. Then move the stitch regulating lever **X** until its upper side is in line with the number of the desired length of stitch. Now move the thumb screw **Y** until the stitch regulating plate (inside) touches the lever **X**, then tighten the thumb screw **Y**.

The machine will now make the indicated number of stitches to the inch in either a forward or reverse direction, depending on whether the lever **X** is at its lowest or highest position.

TO REGULATE THE DIRECTION OF FEED

To feed the material **from you**, push down the stitch regulating lever **X**, **Fig. 17** as far as it will go.

To feed the material **toward you**, raise the stitch regulating lever **X** as high as it will go.

The direction of feeding can be reversed at any point of a seam without removing the work from the machine.

The reverse feed makes it easy to do "back tacking" and to fasten the ends of seams.

TO REGULATE PRESSURE ON PRESSER FOOT

For ordinary sewing, the pressure of the presser foot on the material seldom requires changing. Heavy materials require more pressure than light weight materials. The pressure should be only heavy enough to prevent the material from rising with the needle and to enable the feed to move the work along evenly. To increase the pressure, turn the thumb screw **V**, **Fig. 16** clockwise or downward. To lighten the pressure, turn the thumb screw so that it screws upward.

SINGER Needles should be used
in **SINGER** Machines.

These Needles and their Containers
are marked with the
Company's Trade Mark "SIMANCO." 1

Needles in Containers marked
"FOR SINGER MACHINES"
are NOT **SINGER** made Needles. 2

THREAD TENSIONS

For ordinary stitching, the needle and bobbin threads should be locked in the center of the thickness of the material, thus:



FIG. 18. PERFECT STITCHING

If the tension on the needle thread is too tight, or if that on the bobbin thread is too loose, the needle thread will lie straight along the upper surface of the material, thus:



FIG. 19. TIGHT NEEDLE THREAD TENSION

If the tension on the bobbin thread is too tight, or if that on the needle thread is too loose, the bobbin thread will lie straight along the under side of the material, thus:



FIG. 20. LOOSE NEEDLE THREAD TENSION

TO REGULATE THE NEEDLE THREAD TENSION

The tension on the needle thread can be regulated **only** when the presser foot is down.

The numerals "0 to 9" on the dial C, Fig. 21 indicate the different degrees of tension that can be obtained. The numbers do not denote the size of thread or ounces of tension.

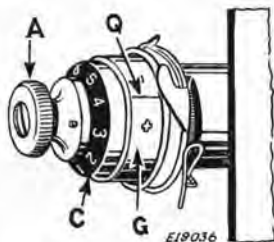

FIG. 21. NEEDLE THREAD TENSION

When the tension has been correctly set for average sewing, note the number at the indicator line **Q**, so that the tension may be reset should it be altered for special work or change in size of thread.

To increase the tension, turn the thumb screw **A** gradually to the right (clockwise) until the required tension is obtained. Each **higher** number denotes increased tension.

To decrease the tension, turn the thumb screw **A** gradually to the left (counter-clockwise) until the required tension is obtained. Each **lower** number denotes less tension.

TO REGULATE THE BOBBIN THREAD TENSION

The tension on the bobbin thread is regulated by the screw **R**, **Fig. 11** in the tension spring on the outside of the bobbin case. To increase the tension, turn the screw **R** over to the right. To decrease the tension, turn this screw over to the left.

When the tension on the bobbin thread has been once properly adjusted, it is seldom necessary to change it, as a correct stitch can usually be obtained by varying the tension on the needle thread.

TO DISASSEMBLE THE NEEDLE THREAD TENSION

NOTE: The needle thread tension, Figs. 21 to 23 inclusive, is correctly adjusted at the factory to produce the complete range of tensions with one revolution of the thumb nut A. There should be no necessity for removing or taking this tension apart. However, if for any reason, it becomes necessary to remove the tension, proceed as follows:

Turn the thumb nut A, Fig. 22 away from you (toward the left) until it stops at "0" on the num-

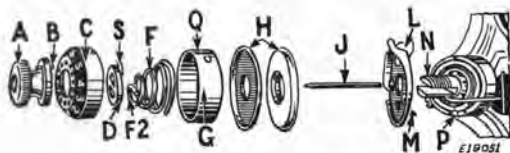

FIG. 22. NEEDLE THREAD TENSION DISASSEMBLED

bered dial C. Press in the dial to disengage the pin B in the thumb nut and remove the thumb nut, dial, stop washer D, tension spring F, indicator G, the two tension discs H, thread guard plate L, and the tension releasing pin J, as shown in Fig. 22. To remove the pin J from the stud N, take off the face plate and tilt it so that the pin will drop out.

TO REASSEMBLE THE NEEDLE THREAD TENSION

Replace the face plate, insert the tension releasing pin in the stud, place the thread guard plate on the

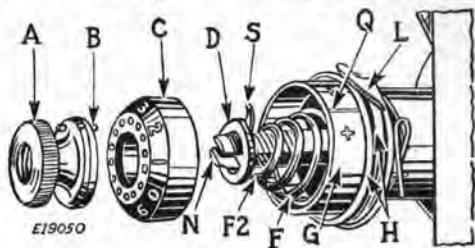

FIG. 23. REASSEMBLING AND REPLACING THE TENSION

stud, being sure that the lug **M**, Fig. 22 engages the short recess **P** to prevent the plate from turning on the stud. Next, replace the two tension discs **H** on the stud, having the flat thread-bearing sides of the discs together. Replace the indicator **G** with the large open side facing end of stud so that the plus and minus signs will be readily seen from a sewing position as shown in Fig. 23. Insert the tension spring **F** in the indicator so that the first half turn **F2** of this spring will straddle the lower half of the tension stud. Guide the stop washer **D** onto the stud so that the extension **S** will be above the tension stud as shown in Fig. 23.

NOTE: If the spring and stop washer are in correct position, the extension **S** will clear the first half-coil of the spring, as shown in Fig. 24.

Next place the numbered dial on the stud so that the numeral 2 is oppo-



FIG. 24

site the stop washer extension **S**, then push the dial to compress the spring so that the thumb nut can be turned onto the stud, carefully guiding the pin in the thumb nut into one of the holes in the numbered dial. Lower the presser bar and turn the thumb nut **A** to the left until it stops at "0." Thread the tension and pull the thread through the tension discs to test the amount of tension at the "0" position. At this point there should be a barely perceptible pull on the thread to indicate that there is a minimum tension which gradually increases with the turn of the thumb nut to the right, providing a full range of tensions from light to heavy within one revolution of the thumb nut. If the pull is too strong for a minimum tension, press in the numbered dial to disengage the pin in the thumb nut from the dial and reset the pin in one of the holes to the **left** of the previous setting. This resetting of the pin will produce less tension at zero. On the other hand, should there be insufficient tension at zero, press in the dial and reset the pin in one of the holes to the **right** of the previous setting. Repeat this process until the desired minimum tension is obtained.

If Correct Stitching is Not Obtained:

If the bobbin thread tension has been disturbed, or a correct stitch cannot be obtained without a very heavy or very light needle thread tension, then the following procedure is recommended:

Using No. 50 thread in the needle and on the bobbin, adjust the needle thread tension as instructed above. Then turn the tension thumb nut to "3" and, with two thicknesses of thin material in the machine, adjust the bobbin thread tension, as instructed on **page 23**, until the stitch is correctly locked in the material as shown in **Fig. 18**.

A wide range of materials and threads can now be accommodated without further adjustment of the bobbin thread tension.

TO OIL THE MACHINE

If the machine is used continuously, it should be oiled daily. If moderately used, an occasional oiling is sufficient.

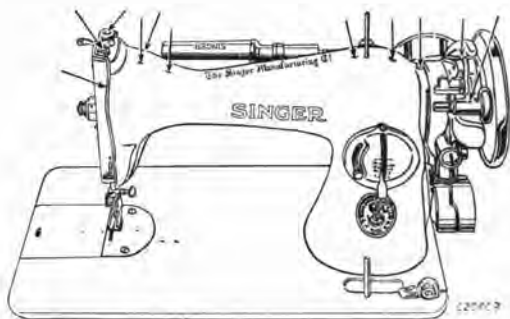

FIG. 25. FRONT VIEW, SHOWING OILING POINTS

Apply one drop of oil at each of the places indicated by the unlettered arrows in **Figs. 25, 27** and **28**.

Draw to the left the bed slide plate, and after removing the lint and dust which may have accumulated (see instructions on **pages 31** and **32**), apply oil to the shuttle race **A, Fig. 30**. The slide should then be closed

Loosen the thumb screw in the round cover plate at the back of the machine, turn the plate upward and fasten by tightening the screw. Turn the balance wheel over toward you until the connecting

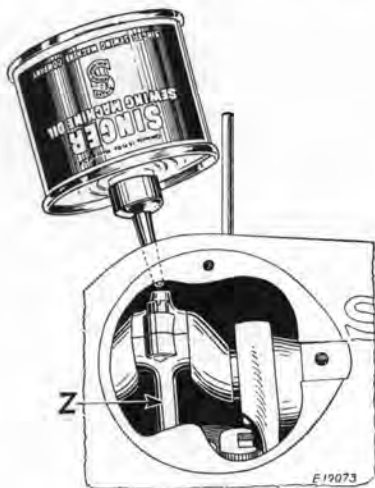

FIG. 26. OILING POINTS AT THE BACK OF THE MACHINE

rod **Z**, **Fig. 26** is at its highest position. Then apply a few drops of oil through the hole in the top of the machine to the wick which is retained in the cap of the connecting rod, as shown in **Fig. 26**. Also oil the other moving parts inside, turn the cover plate down and fasten it as before.

Loosen the screw **A2**, **Fig. 27** near the upper end of the face plate, raise the plate and slip it off over the head of the screw. Apply one drop of oil at each of the places indicated by the unlettered arrows in **Fig. 27**, then replace the face plate and fasten it as before.

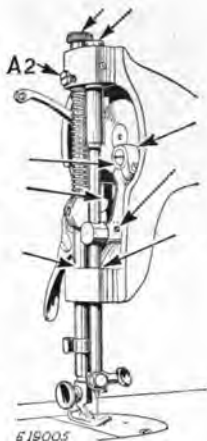

FIG. 27. END VIEW
SHOWING OILING POINTS

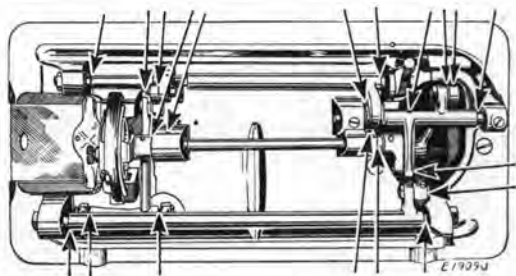

FIG. 28. OILING POINTS IN BASE OF MACHINE

TO LUBRICATE THE MOTOR

NEVER USE OIL OR ORDINARY GREASE FOR LUBRICATING THE MOTOR as they are harmful for this purpose. USE ONLY **SINGER MOTOR LUBRICANT**, a tube of which is supplied with the machine. It is the only lubricant which will positively lubricate the motor.

When the machine is shipped from the factory, the two motor grease cups **A**, **Fig. 29** are filled with sufficient **SINGER MOTOR LUBRICANT** for approximately one year's use. Refill these grease cups at least once a year thereafter.

Turn the machine back on its hinges and remove the two thumb screws from the two grease cups **A** and clean out the interior of the cups. Then insert the tip of the motor lubricant tube into the grease cups as shown in **Fig. 29**, and while holding the tube firmly against the bottom of the grease cups, **squeeze enough grease into each cup to fill them.** Replace and tighten the thumb screws.

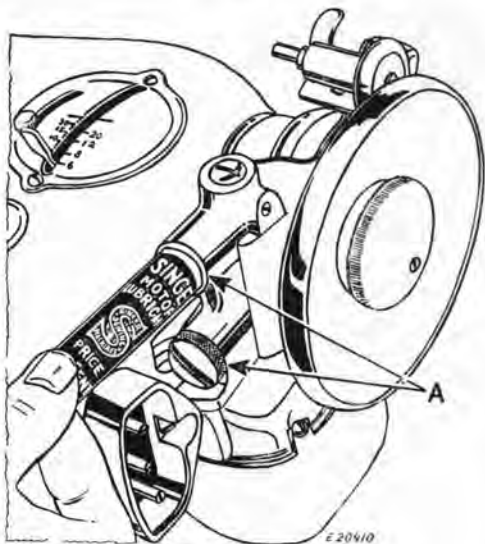

FIG. 29. LUBRICATING THE MOTOR

Machine Working Heavily

If the machine runs hard after standing idle for some time, use a little kerosene in the oiling places, run the machine rapidly, then wipe clean and oil.

To Clean the Stitch Forming Mechanism

After considerable use, the stitch forming mechanism in the bed of the machine may become clogged with lint and this may interfere with the perfect operation of the machine.

Occasionally remove the shuttle from the machine, as instructed below and remove any lint, etc., which has accumulated in the machine.

TO REMOVE THE SHUTTLE

Draw the bed slide plate to the left. Turn the balance wheel over toward you until the needle is

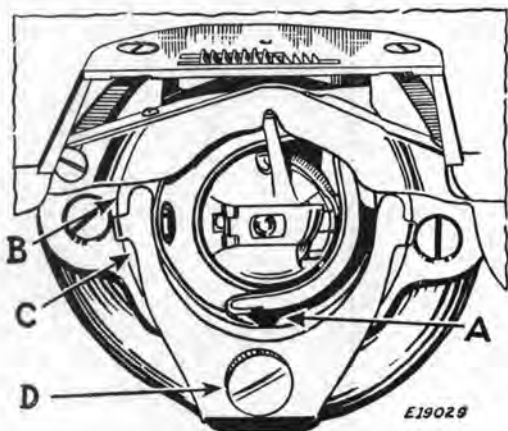

FIG. 30. SHOWING POSITION OF SHUTTLE FOR REMOVAL FROM MACHINE

at its highest point and the point of the shuttle is at the position shown in Fig. 30.

Remove the bobbin case and bobbin. Take out the thumb screw **D**, Fig. 30, also the spring **C**, Fig. 30 and the shuttle race back **B**, Figs. 30 and 31. The shuttle **A**, Figs. 30 and 31 may now be easily removed and the parts cleaned.

TO REPLACE THE SHUTTLE

See that the needle is at its highest point. Replace the shuttle with its point **A** in the position shown

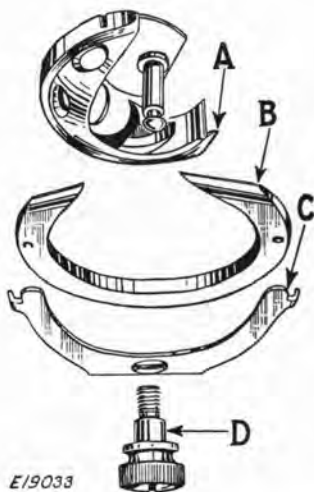

E19033

FIG. 31. SHUTTLE AND PARTS REMOVED FROM MACHINE

in **Fig. 31**, then replace the other parts in the order illustrated in **Fig. 31**. Replace and tighten the thumb screw **D**. Replace the bobbin and bobbin case and close the bed slide plate.

SEWING SUGGESTIONS

Breaking of needles might be caused by:

- (1) Improper size of needle for thread and material.
See **page 9.**
- (2) Needle bent.
- (3) Pulling of material when stitching.
- (4) Needle striking improperly fastened presser foot or attachments.
- (5) Crossing too thick seams with too small a needle.

Breaking of needle thread might be caused by:

- (1) A knot in the thread.
- (2) Improper threading. See **page 11.**
- (3) Upper tension too tight. See **page 22.**
- (4) Needle set incorrectly. See **page 10.**
- (5) Needle blunt or bent.
- (6) Thread too coarse for needle. See **page 9.**
- (7) Roughened hole in throat plate.
- (8) Improper arrangement of threads to commence sewing. See **page 17.**

Breaking of bobbin thread might be caused by:

- (1) Improper threading of the bobbin case.
See **page 15.**
- (2) Bobbin thread tension too tight. See **page 23.**
- (3) Bobbin wound unevenly.

Skipping of stitches might be caused by:

- (1) Improper setting of needles. See **page 10.**
- (2) Needle blunt or bent.
- (3) Needle too small for thread. See **page 9.**
- (4) Needle rubbing presser foot.

Free instruction for using the machine is gladly given at any SINGER Shop.

DARNING OR EMBROIDERING

Turn the machine back on its hinges. Unscrew as far as possible the thumb screw **B**, **Fig. 32** which is located in the lower end of the slot of the feed

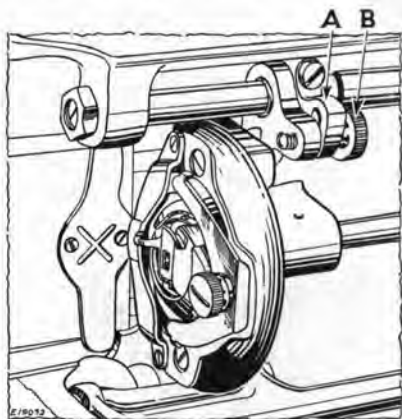

FIG. 32. ADJUSTMENT FOR DARNING OR EMBROIDERING

lifting crank **A**, **Fig. 32**. The feed is thus rendered inoperative and will not interfere with the free movement of the work. Bring the machine forward into place.

Move the stitch regulating lever **X**, **Fig. 17** to its neutral position in the center of the slot at the front of the machine.

Remove the presser foot and let down the presser bar lifter **C**, **Fig. 16** to restore the tension on the needle thread which is released when the lifter is raised.

Draw up the bobbin thread as instructed on **page 17**.

When darning flat work, it is advisable to use embroidery hoops to hold the work.

Place the work in the machine, having the unworn part near the hole under the needle. Commence the darning by making a line of stitches across the hole a little longer than the width of the hole. Continue making parallel lines

of stitches across the hole, moving the work backward and forward and at the same time gradually moving

the work side-wise until the hole is covered with lines of stitches running across the hole. Then commence as before and move the work lengthwise of the hole until the stitches across the hole are completely covered and the darn is finished.



FIG. 33. DARNING IN PROCESS

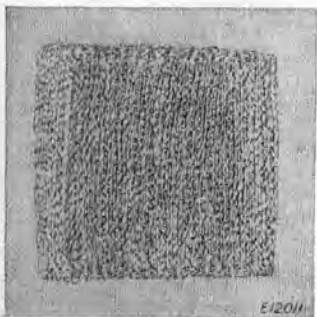

FIG. 34. DARNING FINISHED

When you have finished the darning or embroidery, raise the presser bar lifter and replace the presser foot. Turn the machine back on its hinges and move the thumb screw **B, Fig. 32** down to the bottom of the slot of the feed lifting crank **A, Fig. 32** and make sure that the thumb screw is firmly tightened. Bring the machine forward into place, return the stitch regulating lever **X, Fig. 17** to its original position and the machine is ready for regular stitching.

Stockings and socks, underwear, etc., can be more conveniently darned on the machine with the SINGER Darner which can be purchased at any SINGER Shop or from any SINGER Salesman.

**SINGER Needles should be used
in SINGER Machines.**

**These Needles and their Containers
are marked with the
Company's Trade Mark "SIMANCO." 1**

**Needles in Containers marked
"FOR SINGER MACHINES"
are NOT SINGER made Needles. 2**

INSTRUCTIONS

FOR USING

THE ATTACHMENTS

THE FOOT HEMMER



FIG. 35
FOOT HEMMER

The foot hemmer may be used for hemming the edge of the material, making hemmed and felled seams and for hemming and sewing on lace in one operation.

To Attach the Foot Hemmer

Raise the needle to its highest point, remove the presser foot and attach the foot hemmer to the presser bar in place of the presser foot.

Pull up the bobbin thread as instructed on **page 17**.

To Start the Hem at the Edge

- (1) Fold edge of material twice, about $\frac{1}{8}$ inch each time, for a distance of about two inches. Crease folds.
- (2) Lay about three inches of needle and bobbin threads back under hemmer. Place creased edge of material under hemmer with end of hem directly under needle. Lower hemmer and tack end of hem with two machine stitches.

(3) Raise hemmer. Pull threads and hem slightly from you with left hand, then while holding threads, draw material toward you with right hand into scroll of hemmer until tacked end is caught in hemmer, as shown in **Fig. 36.**

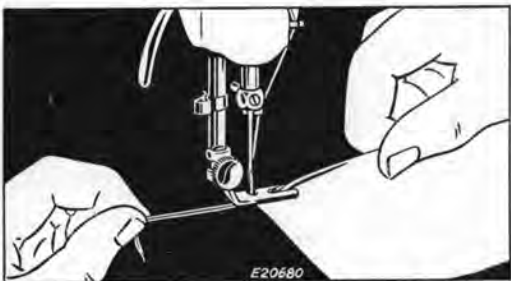

FIG. 36. STARTING HEM AT VERY END OF MATERIAL.

(4) Lower hemmer and commence to sew, slightly pulling threads back while sewing. **Keep mouth of hemmer full to produce a smooth, even hem,** as shown in **Fig. 36A.**

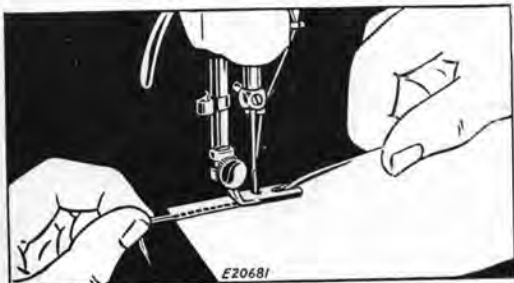

FIG. 36A. HEMMING EDGE OF MATERIAL AND PULLING BACK THREADS WHILE SEWING

To Make a Hemmed Seam with the Foot Hemmer

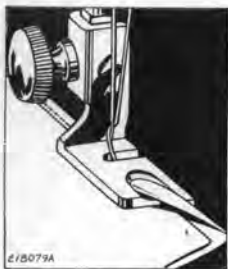

FIG. 37
MAKING A HEMMED SEAM
(FIRST OPERATION)

(1) When making this seam, the garment must first be fitted and the edge of the material trimmed, allowing for about $\frac{1}{8}$ inch seam. Insert the two edges of the material, right sides together, in the hemmer in the same manner as a single hem as shown in Fig. 37. If the material is bulky, place the edge of the upper piece of material about $\frac{1}{8}$ inch to the left of the edge of the under piece.

(2) The free edge of the hemmed seam may be stitched flat to the garment, if desired. To do this, open the work out flat, wrong side up, then insert the hem in the scroll of the hemmer, holding the edge of the hem in position while it is being stitched. If the seam is stitched flat to the garment, one row of stitching is visible on the right side.

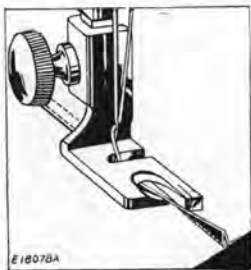

FIG. 38
MAKING A HEMMED SEAM
(SECOND OPERATION)

To Make a Felled Seam with the Foot Hemmer



(1) Place the right sides of the material together, having the edge of the upper piece about $\frac{1}{8}$ inch to the left of the edge of the under piece. Stitch the two pieces together, using the hemmer as a presser foot. Guide both pieces by the projecting toe of the hemmer, as shown in **Fig. 39**.

**FIG. 39. MAKING A FELLED SEAM
(FIRST OPERATION)**

(2) Open the work out flat, wrong side up, and hem the free edge of the seam, stitching it flat to the garment as shown in **Fig. 40**.

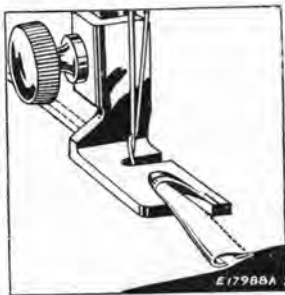

**FIG. 40. MAKING A FELLED SEAM
(SECOND OPERATION)**

To Hem and Sew on Lace in One Operation

- (1) Start the hem in the regular way.
- (2) Hold the hem in position with the needle.

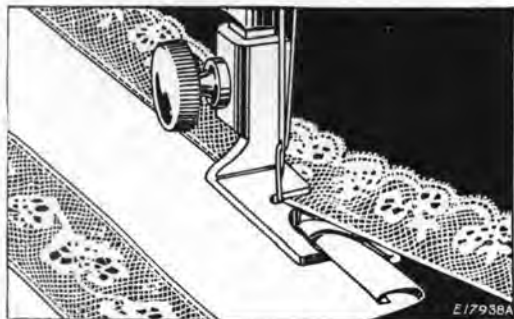

FIG. 41. HEMMING AND SEWING ON LACE

- (3) Raise the presser bar and insert the edge of the lace in the slot of the hemmer and back under the hemmer.
- (4) Lower the presser bar and commence sewing, catching the edge of the lace with the needle.
- (5) Guide the hem with the right hand and the lace with the left, being careful not to stretch the lace as it enters the hemmer.

ADJUSTABLE HEMMER

To Make Hems from $3/16$ to $15/16$ Inch Wide

- (1) Attach the adjustable hemmer to the presser bar in place of the presser foot.
- (2) Pull up the bobbin thread, as instructed on **page 17**.

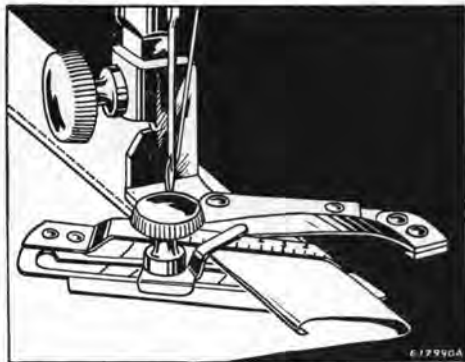

FIG. 42. SHOWING HOW ADJUSTABLE HEMMER IS USED FOR MAKING HEMS UP TO $15/16$ INCH WIDE

- (3) Loosen the thumb screw on the hemmer and move the scale until the pointer registers with the number of the desired width of hem, No. 1 indicating the narrowest hem and No. 8, the widest, then tighten the thumb screw.
- (4) Place the cloth in the hemmer and draw it back and forth until the hem is formed, as shown in **Fig. 42**.
- (5) Draw the end of the hem back under the needle, lower the presser bar and commence to sew.
- (6) Guide sufficient cloth into the hemmer to turn the hem properly.

To Make Hems Wider than 15/16 Inch

- (1) Loosen the thumb screw on the hemmer, move the scale to the right as far as it will go, then swing it toward you, as shown in **Fig. 43**, and tighten the thumb screw.
- (2) Fold and crease the desired width of hem.

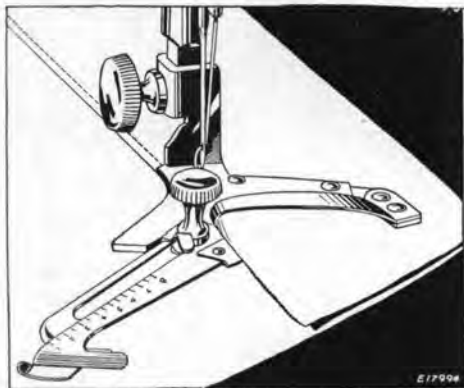

FIG. 43. SHOWING HOW ADJUSTABLE HEMMER IS USED FOR MAKING HEMS WIDER THAN 15/16 INCH

- (3) Place the fold under the extension at the right of the hemmer and the edge into the folder, as shown in **Fig. 43**.
- (4) Draw the end of the hem back under the needle, lower the presser bar and commence to sew.
- (5) Guide the cloth to keep the hem flat.

MULTI-SLOTTED BINDER

This multi-slotted binder will apply **unfolded bias binding** $\frac{1}{8}$ inch in width and commercial **folded binding** in sizes **1, 2, 3, 4** and **5** to the seams or to the edges of garments. These sizes of folded binding are $\frac{1}{4}$, $\frac{5}{16}$, $\frac{3}{8}$, $\frac{7}{16}$ and $\frac{1}{2}$ inch in width, respectively, and are fed through slots of corresponding sizes in the binder scroll. See **Fig. 44**. Binding may be purchased in a variety of materials and colors.

For convenience in determining the correct width of **unfolded binding** ($\frac{1}{8}$ inch), this measurement is marked on the binder, as shown in **Fig. 44**.

The two upright guide pins shown in **Fig. 44** eliminate manual guiding of the binding.

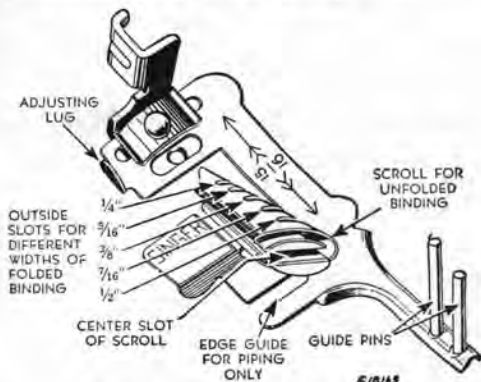

FIG. 44. MULTI-SLOTTED BINDER 160359

The wide range of bindings that can be applied with this binder makes it useful for a large variety of work. It will be found particularly advantageous for making children's wear, lingerie, summer dresses, and other dainty articles which call for the narrower bindings.

As two different widths of binding of contrasting color can be fed through the binder at the same time, attractive binding and piping effects can be produced in one operation.

To Attach the Binder

Raise the needle to its highest position, then attach the binder to the presser bar in place of the presser foot.

See that the needle enters the center of the needle hole.

To Insert the Binding In the Binder

Cut all binding to a long point to the left, as shown in **Fig. 45**.

Folded bias binding must be inserted in the slot or slots of corresponding sizes. See **Fig. 48**.

Unfolded or raw edge bias binding must be inserted in the open end of the scroll. See **Fig. 46**.



Fig. 45

After inserting the pointed end of the binding in the binder, push it through until the full width of the binding is under the needle.

Guide the binding by means of the two upright pins, as shown in **Figs. 46** and **48**.

To Insert the Garment in the Binder

Place the edge to be bound as far to the right as it will go in the center slot of the scroll **C2**, as shown in **Fig. 46**, and draw it back under the binder foot.

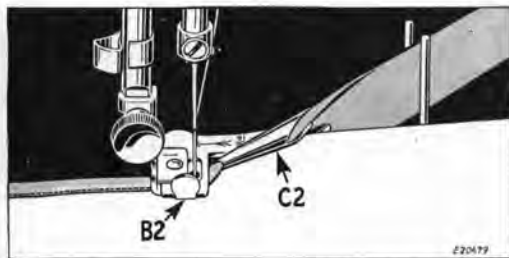

FIG. 46. BINDING WITH UNFOLDED BINDING

Lower the binder by means of the presser foot lifter, and commence to sew. Keep the material well within the center slot of the scroll so that the edge will be caught in the binding.

To Adjust the Binder

To bring the inner edge of the binding closer to the stitching, move the scroll **C2**, **Fig. 46** to the right by means of the lug **B2**, **Fig. 46**. This is the usual adjustment when binding straight edges.

When binding curves, move the scroll to the left to bring the inner edge of the binding farther from the stitching and allow for the sweep of the curve.

Piped Edge

To produce a **piped edge** on garments, move the lug **B2**, **Fig. 47** to the left to bring the stitching about midway of the folded binding.

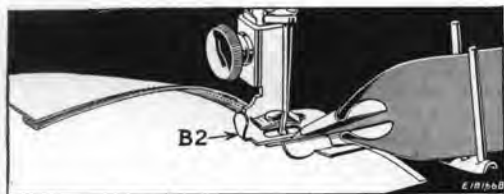

FIG. 47

POSITION OF GARMENT AND BINDING WHEN PIPING EDGES

Crease the raw edges of the garment toward the wrong side about $\frac{1}{8}$ inch, and insert the folded edge, raw edges uppermost, into the edge guide on the binder, and **beneath** the binding.

When stitched, both sides of the garment will be finished, and the right side will show the piped edge.

Piping and Binding in One Operation

A garment can be piped and bound in one operation, as shown in Fig. 48.

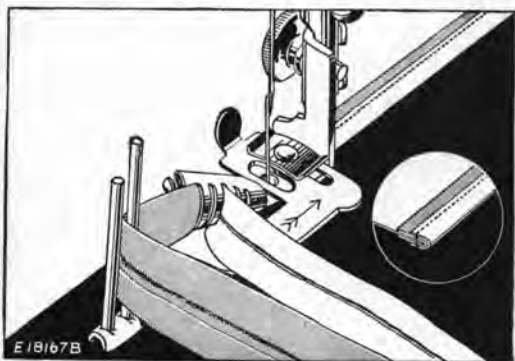

FIG. 48. PIPING AND BINDING IN ONE OPERATION

IMPORTANT: When piping and binding at the same time, as shown above, insert the **narrow width** of binding **first** in its slot, then insert the **wider width** in its slot. **Two consecutive widths should not be used at the same time.** That is, if No. 1 is used, the wider binding should not be smaller than No. 3. If No. 2 is used, the wider binding should not be less than No. 4. **Never use Nos. 1 and 2, or 2 and 3, etc., together.**

Use the upright guide pins to guide the wider of the two widths of binding, as shown in Fig. 48.

To Bind Outside Curves

Allow the edge to be bound to pass freely through the scroll without crowding against the scroll wall. The material must be guided from the back of the binder and to the left, permitting unfinished edges to swing naturally into the scroll of the binder.

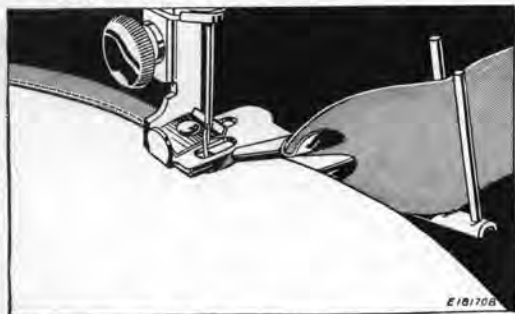

FIG. 49. BINDING AN OUTSIDE CURVE

Never pull the binding while it is being fed through the binder, as this may stretch the binding, making it too narrow to stitch or to turn in the edges.

When binding curves, turn the material only as fast as the machine sews.

Do not push the material in too fast as this will pucker the edge.

Do not stretch the material as this will distort the edge so that the curve will not have the proper shape when finished.

If the stitching does not catch the edge of the binding, adjust the scroll slightly to the left.

To Bind Inside Curves

When binding an inside curve, straighten out the edge of the material while feeding it into the binder, being careful not to stretch the material.

Soft materials like batiste or crepe de chine require a row of stitching added close to the edge of the curve before binding.

To Apply French Folds To Curves

Place the material under the binder and stitch the binding onto the face of the material, as shown in Fig. 50.

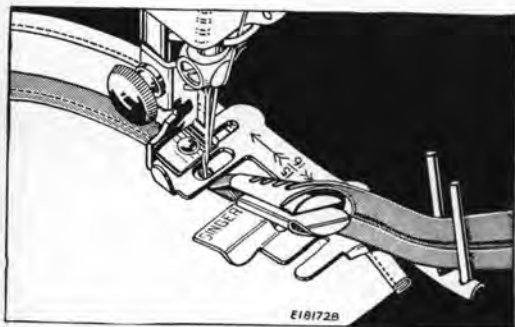

FIG. 50. APPLYING A FRENCH FOLD

For guidance in applying the rows of French folds, mark the material with a line of basting stitches or with chalk or pencil.

THE EDGE-STITCHER

This attachment should be used when the stitching must be kept accurately on the extreme edge of the material. It is also useful for sewing together laces, insertions and embroideries, sewing in position hemmed or folded edges, piping or sewing flat braid to a garment.

To Adjust the Edge-Stitcher

Fasten this attachment to the presser bar in place of the presser foot.

See that the needle enters the center of the needle hole.

The distance from the line of stitching to the edge of the material in the slots is regulated by moving the lug **D2**, **Fig. 51** to the right or left.

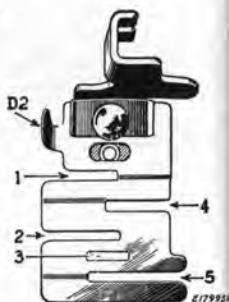

FIG. 51

THE EDGE-STITCHER.

To Sew Lace Together

- (1) Insert one of the laces in slot **1** of the edge-stitcher and the other in slot **4**, **Fig. 51**.
- (2) Adjust the lug **D2** until the edges to be joined are caught by the stitching.
- (3) Slightly overlap the edges of the lace while stitching to keep them against the ends of the slots.
- (4) Loosen both thread tensions to avoid puckering of fine lace.

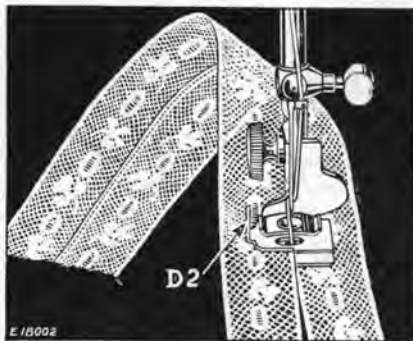

FIG. 52. SEWING LACE TOGETHER

To Insert Lace or Ribbon

- (1) Fold the edge of the material to which the lace or ribbon is to be sewn and insert it in the slot 1, **Fig. 51** of the edge-stitcher.
- (2) Insert the lace or ribbon in the slot 4 of the edge-stitcher and proceed to sew.
- (3) Cut away the surplus folded material close to the stitching.

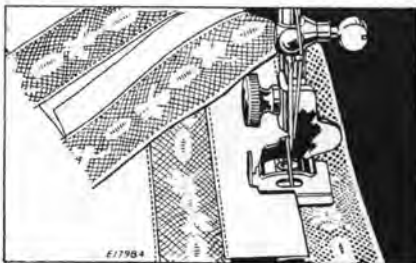

FIG. 53. SETTING IN LACE INSERTION

To Pipe with the Edge-Stitcher

- (1) Cut the piping bias and twice the width of the slot **3** so that it can be folded once.
- (2) Insert the piping with its folded edge to the left in slot **3** and the edge to be piped in slot **4**, **Fig. 51**.

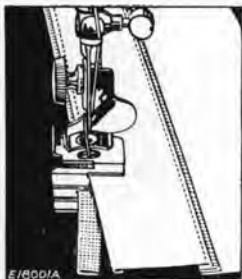

FIG. 54
PIPING WITH EDGE-STITCHER

To Apply Folded Bias Tape or Military Braid

- (1) Place the garment under the edge-stitcher and the tape in slot **1** or **4**, **Fig. 51**.

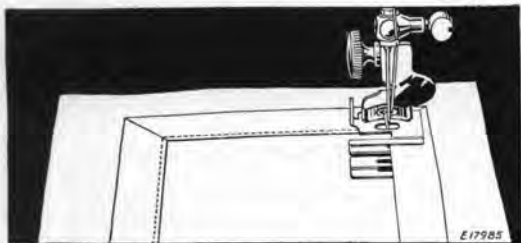

FIG. 55. APPLYING BIAS FOLDED TAPE

- (2) To make square corners, sew to the turning point, remove the tape from the attachment, form the corner by hand, replace the tape and continue stitching. See **Fig. 55**.
- (3) To space two or more parallel rows, mark the material with a guide line, using a crease, chalk or basting thread.

To Stitch a Wide Hem

- (1) A wide hem may be stitched evenly on sheets, pillow slips, etc., with the edge-stitcher after the hem has been measured and the edge turned.
- (2) Insert the edge in slot 5, Fig. 51, and adjust the lug D2 to stitch as close to the edge as desired.

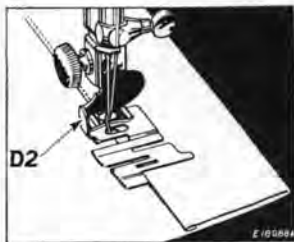

FIG. 56.
MAKING A WIDE HEM

To Make a French Seam

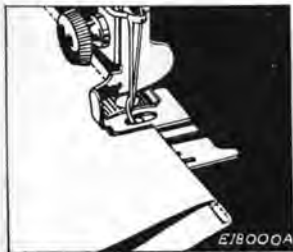

FIG. 57.
MAKING A FRENCH SEAM
(SECOND OPERATION)

- (1) To make a uniform width French seam, insert the two edges to be joined, wrong sides together, in slot 1 or 2, Fig. 51 and stitch close to the edge.
- (2) Fold both right sides together and insert the back of the seam in the slot 1 and stitch, allowing just enough margin to conceal the raw edges.

To Tuck with the Edge-Stitcher

The maximum width of tuck that can be made with the edge-stitcher is $\frac{1}{8}$ inch.

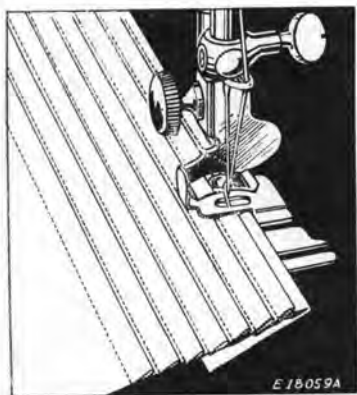

FIG. 58. TUCKING WITH THE EDGE-STITCHER

- (1) Fold and crease the material for the desired width of tuck.
- (2) For succeeding tucks, fold the material the desired distance from the previous tuck, running the fold lengthwise over a straight edge, then crease the folds.
- (3) Insert the creased folds in the slot **1**, **Fig. 51** and adjust the edge-stitcher to the right or left for the desired width of tuck. Use a light tension, short stitch and fine thread and needle.

GATHERING FOOT

To Shirr with the Gathering Foot

- (1) Fasten the gathering foot to the presser bar in place of the presser foot.

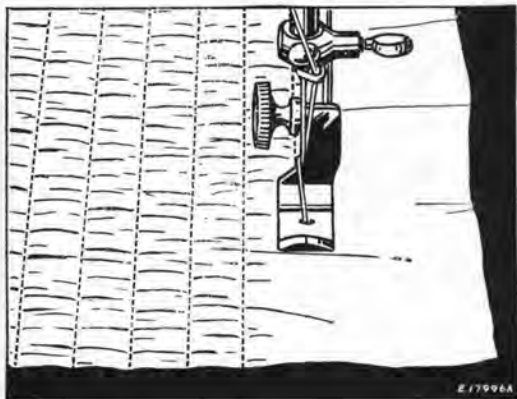

FIG. 59. SHIRRING WITH THE GATHERING FOOT

- (2) Place the material under the gathering foot and stitch in the usual way.
- (3) The fullness of the shirring or amount of gathering is regulated by the length of stitch. A longer stitch increases the fullness of the gathers.

THE RUFFLER

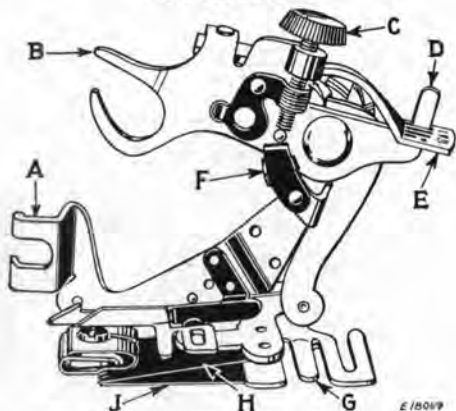

FIG. 60. PRINCIPAL PARTS OF THE RUFFLER

- A—Foot**—attaches ruffler to the presser bar.
- B—Fork Arm**—straddles the needle clamp.
- C—Adjusting Screw**—regulates fullness of gathers.
- D—Projection**—engages the slots in adjusting lever.
- E—Adjusting Lever**—sets ruffler for gathering or for making a plait once at every 6 stitches or once every 12 stitches as desired; also for disengaging ruffler, when either plaiting or gathering is not desired.
- F—Adjusting Finger**—regulates width or size of plaits.
- G—Separator Guide**—contains slots into which edge of material is placed to keep the heading of ruffle even; also for separating the material to be ruffled from the material to which the ruffle is to be attached.
- H—Ruffling Blade**—pushes the material in plaits up to the needle.
- J—Separator Blade**—prevents ruffling blade teeth from contacting feed or material to which ruffle or plaiting is applied.

To Attach The Ruffler

- (1) Raise the needle to its highest point.
- (2) Loosen the presser foot thumb screw and attach the ruffler to the presser bar in place of the presser foot, at the same time placing the fork arm **B** astride the needle clamp.
- (3) See that the needle enters the center of the needle hole in the ruffler.

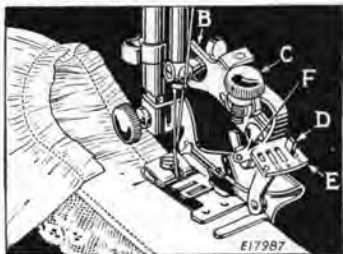

FIG. 61. GATHERING WITH THE RUFFLER

To Adjust The Ruffler For Gathering

- (1) Swing the adjusting finger **F** away from the needle.
- (2) Raise the adjusting lever **E** and move it until the projection **D** can be entered in the slot marked "1."

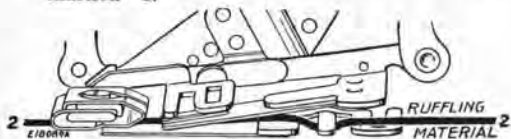

FIG. 62. CORRECT POSITION FOR MATERIAL TO BE RUFFLED

- (3) Insert the material to be ruffled between the two blue blades **Line 2, Fig. 62.**
- (4) Draw the material slightly back of the needle, lower the presser bar and commence to sew.
- (5) For fine gathering, turn the adjusting screw **C** upward and shorten the stitch.
- (6) For full gathering, turn the adjusting screw **C** downward and lengthen the stitch.

To Make a Ruffle and Sew it to a Garment in One Operation

- (1) Insert the material to be ruffled between the two blue blades **Line 2, Fig. 63.**

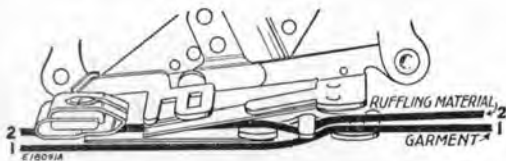

FIG. 63. CORRECT POSITIONS FOR THE MATERIALS

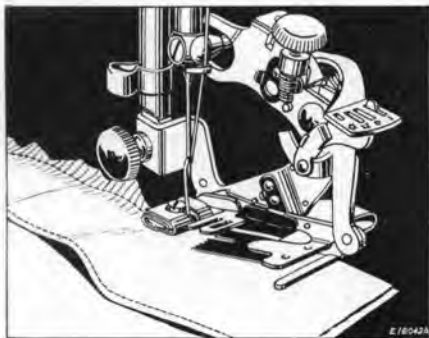

FIG. 64

MAKING A RUFFLE AND ATTACHING IT IN ONE OPERATION

- (2) Place the material to which the ruffle is to be attached under the separator blade **Line 1, Fig. 63.**
- (3) Proceed the same as for plain gathering.

To Make a Ruffle and Attach it with a Facing in One Operation

- (1) Insert the material to be ruffled between the two blue blades **Line 2, Fig. 65.**

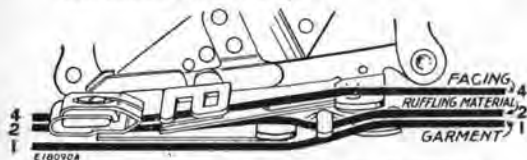

FIG. 65. CORRECT POSITIONS FOR THE MATERIALS

- (2) Place the material to which the ruffle is to be attached under the separator blade **Line 1, Fig. 65.**
- (3) Place the facing material over the upper blue blade **Line 4, Fig. 65.**

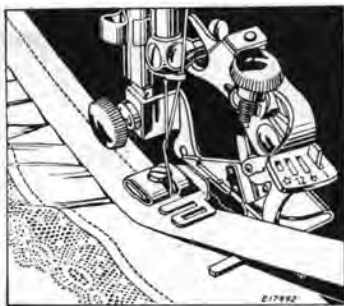

FIG. 66. MAKING A RUFFLE AND ATTACHING IT WITH A FACING IN ONE OPERATION

- (4) If the facing is to be on the **right side** of the garment, place the wrong sides of the garment and ruffle together.
- (5) If the facing is to be on the **wrong side**, place the right sides of the garment and ruffle together.

To Pipe a Ruffle

- (1) Insert the material to be ruffled between the two blue blades **Line 3, Fig. 67**. This material must not exceed $1\frac{1}{4}$ inches in width.



FIG. 67. CORRECT POSITIONS FOR THE MATERIALS

- (2) The piping material is usually cut on the bias and it should be about $\frac{1}{4}$ inch wide when folded in the center. Place the piping material in the ruffler, following **Line 5, Fig. 67** with the folded edge of the piping to the right.

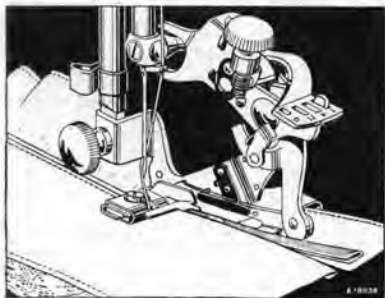

FIG. 68. PIPING A RUFFLE

- (3) Fold the edge of the material to which the piping and ruffling are to be attached and insert it in the ruffler, following **Line 6, Fig. 67**.

To Adjust the Ruffler for Plaiting

- (1) Raise the adjusting lever **E** and move it until the projection **D** can be entered in the slot marked "6". The ruffler will then plait once every six stitches. To plait once every 12 stitches, have the projection **D** enter the slot "12" in the adjusting lever **E**.

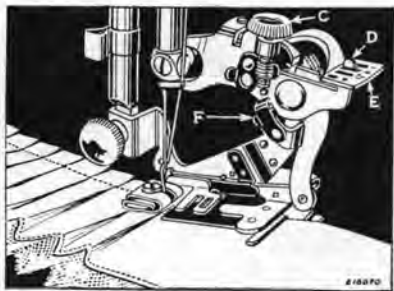

FIG. 69. PLAETING WITH THE RUFFLER

- (2) Insert the material to be plaited between the two blue blades **Line 2**, Fig. 70.

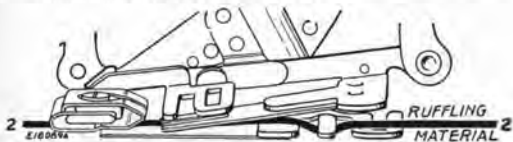

FIG. 70. CORRECT POSITION FOR THE MATERIAL

- (3) To increase the width of plait, move the adjusting finger **F** back toward the needle and turn the adjusting screw **C** downward. To make a smaller plait, turn the adjusting screw **C** upward. The distance between plaits is regulated by the length of stitch.

To Adjust the Ruffler for Group Plaiting

- (1) To make the space between the groups of plaits, raise the adjusting lever **E** and move it until the projection **D** can be entered in the small slot indicated by the star on the adjusting lever **E**. The ruffler will then stop plaiting and plain stitching will be made.

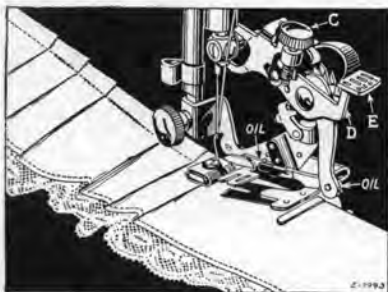

FIG. 71. GROUP PLAITING WITH THE RUFFLER

- (2) When the desired space is made, set the projection **D** in either of the slots "6" or "12".
- (3) Insert the material to be plaited between the two blue blades **Line 2, Fig. 72**.

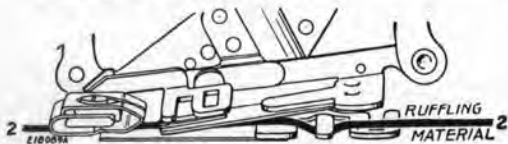

FIG. 72. CORRECT POSITION FOR THE MATERIAL

To Oil The Ruffler

Occasionally apply a drop of oil to the working parts of the ruffler at each of the places indicated in **Fig. 71**.

THE IMPORTANCE OF USING
SINGER* NEEDLES FOR YOUR
SEWING MACHINE

You will obtain the best stitching results from your sewing machine if it is fitted with a **SINGER** Needle.

SINGER Needles can be purchased from any **SINGER** Shop or **SINGER** Salesman.

SINGER Needles are contained in the **SINGER** Green Needle Packet with the famous red letter "S" upon it.



FOR YOUR PROTECTION!

SINGER sells its machines only through SINGER SEWING CENTERS, identified by the Red "S" on the window, and never through department stores or other outlets.

When your machine needs servicing, call your SINGER SEWING CENTER and be sure of warranted SINGER parts and service.

Check local SINGER address in phone book.

SINGER SEWING MACHINE COMPANY