

Form 18376
Revised
January, 1930

INSTRUCTIONS
FOR USING
SINGER SEWING MACHINES
Nos. 127 and 128

(WITH ATTACHMENTS 120604)

LOCK STITCH, FOR FAMILY USE

When Requiring
Needles, Oil,
Parts or
Repairs for
Your Machine



Look for the
Red "S"
There are
Singer Shops in
Every City

THE SINGER MANUFACTURING CO.

PRINTED IN U. S. A.

THE IMPORTANCE OF USING
SINGER OIL FOR YOUR
SEWING MACHINE

—
“The Best is the Cheapest”
—

KNOWING from many years' experience the great importance of using GOOD OIL, we put up an extra quality machine oil, in bottles, especially prepared for sewing machines.

—
See that the words “THE SINGER MANUFACTURING COMPANY” are moulded upon the bottle.

—
Copyright, U.S.A., 1915, 1916, 1923, 1928 and 1929,
by The Singer Manufacturing Company
All Rights Reserved for all Countries

SINGER SEWING MACHINES
Nos. 127 and 128

(WITH ATTACHMENTS 120604)

(VIBRATING SHUTTLE)

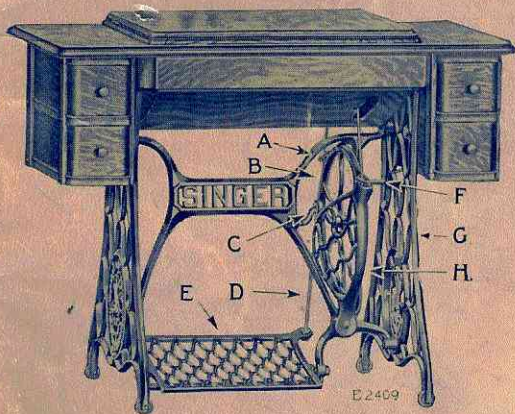

PARTS OF THE MACHINE STAND

- | | |
|---------------------|-----------------|
| A. BELT GUIDE | E. TREADLE |
| B. BAND WHEEL | F. BELT SHIFTER |
| C. BAND WHEEL CRANK | G. LEG |
| D. PITMAN | H. DRESS GUARD |

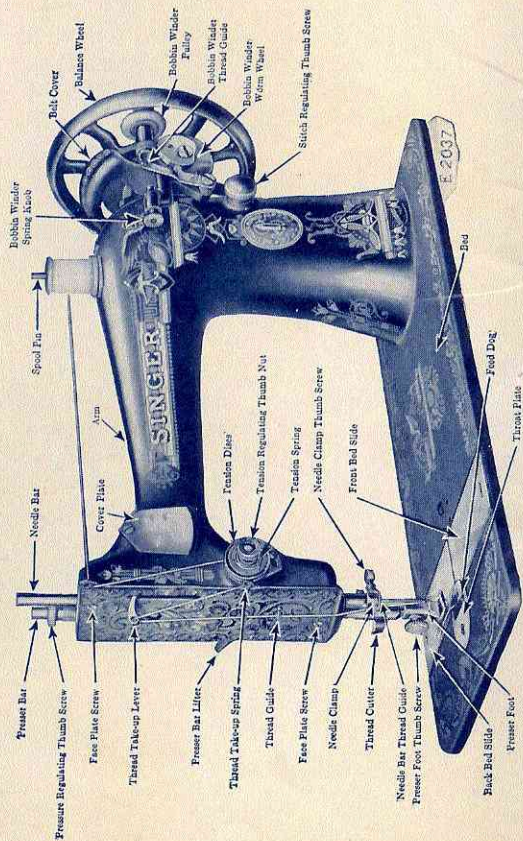

DESCRIPTION

Machines Nos. 127-3 and 128-3 make the lock stitch and are designed for family use.

Instructions for Operating the Machines

Raise the presser foot (B, Fig. 3) by means of the presser bar lifter (C, Fig. 3) to prevent injury to the foot (B, Fig. 3) and feed (A, Fig. 3).

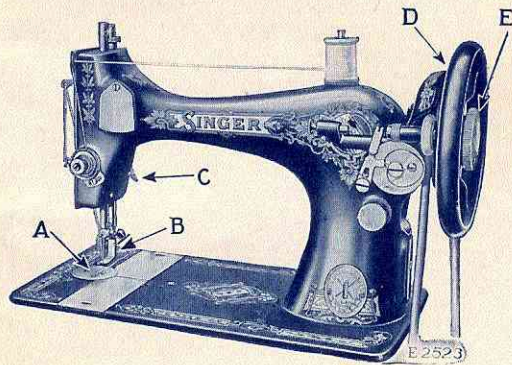

FIG. 3. FRONT VIEW OF THE MACHINE

It is necessary to understand the stop motion (E, Fig. 3) by which the balance wheel (D, Fig. 3) can be released when required, thus enabling the operator to become proficient in the use of the treadle and permitting the winding of bobbins without

running the stitching mechanism. It also allows the operator to wind bobbins without removing partially sewn work and without unthreading the machine.

To release the balance wheel (D, Fig. 3, page 3), turn the stop motion screw (E, Fig. 3) over toward you. It will be necessary to hold the balance wheel while loosening the stop motion screw.

After releasing the balance wheel, place your feet upon the treadle and with the right hand turn the balance wheel over toward you. This will start the band wheel, treadle and pitman, the sewing mechanism having been disconnected.

Continue the motion thus begun by an alternate pressure of heel and toe, until a regular and easy movement is acquired, and the balance wheel kept in continuous rotation by use of the feet alone.

When you are thoroughly familiar with the treadle movement and can restart the machine without turning the balance wheel in the wrong direction, tighten the stop motion screw to connect the balance wheel with the stitching mechanism.

Place a piece of cloth under the presser foot, let the foot down upon it, and operate the machine in this way without being threaded, until you have become accustomed to guiding the material.

To Ensure Perfect Action of the Machine

The balance wheel must always turn over toward the operator.

Do not run the machine with the presser foot resting on the feed without cloth under the presser foot.

Do not run the machine when both shuttle and needle are threaded unless there is material under the presser foot.

Do not try to help the machine by pulling the fabric lest you bend the needle. The machine feeds the work without assistance.

Both slides over the shuttle should be kept closed when the machine is in operation.

To Remove the Shuttle

Draw toward you the front slide in the bed of the machine and turn the balance wheel over toward

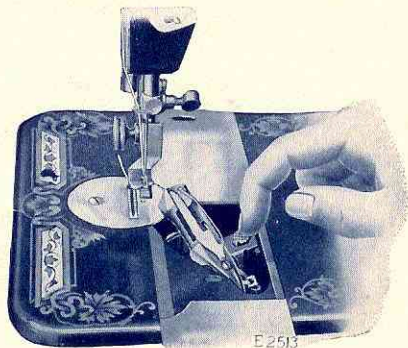

FIG. 4. REMOVING THE SHUTTLE

you until the shuttle comes full under the opening. Press the forefinger of the right hand upon the shuttle ejector as shown in Fig. 4, this will raise the shuttle so that it can be easily taken out. Turn the open end of the shuttle downward and the bobbin will drop out.

To Wind the Bobbin

Release the balance wheel (D, Fig. 3, page 3) by turning the stop motion screw (E, Fig. 3) over toward you.

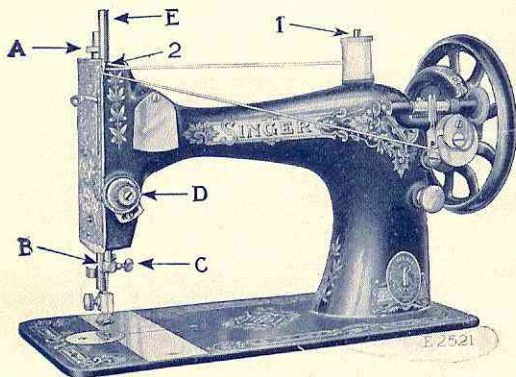

FIG. 5. MACHINE THREADED FOR WINDING THE BOBBIN

Draw to the left the knot (A, Fig. 6, page 7) and place the bobbin between the cups (B and C, Fig. 6), then release the knob. Push the bobbin winder pulley (D, Fig. 6) against the hub of the balance wheel, and turn the balance wheel until the thread guide (4, Fig. 6) moves to the extreme right. Put the spool of thread on the spool pin (1, Fig. 5). Pass the end of the thread into the thread guide (2, Fig. 5) at the top of the face plate, then up into the lower eyelet (3, Fig. 6) of the

bobbin winder thread guide, into the notch (4, Fig. 6). With the thumb and forefinger of the

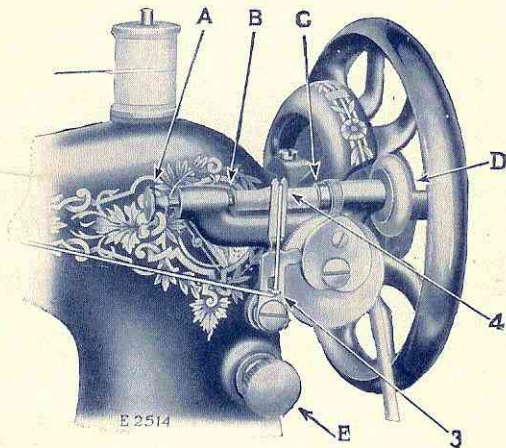

FIG. 6. WINDING THE BOBBIN

left hand press the bobbin lightly to the left and place the end of the thread between the bobbin and the cup (C, Fig. 6) at the right. Then operate the machine the same as for sewing. When the bobbin is filled, remove it from the bobbin winder, pull the bobbin winder away from the hub of the balance wheel and turn the stop motion screw over from you to connect the stitching mechanism.

To Thread the Shuttle

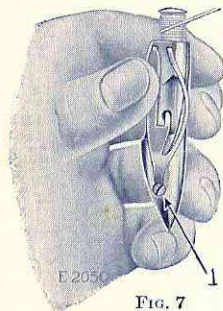

FIG. 7

Hold the shuttle between the thumb and fingers of the left hand as shown in Fig. 7. Place the bobbin into the shuttle with the thread drawing toward the right from the side of the bobbin nearest you, as shown in Fig. 7.

Place the forefinger of the left hand on the end of the bobbin and draw the thread downward into the long slot in the shuttle as far as it will go, as shown in Fig. 8.

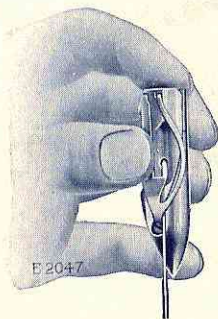

FIG. 8

Then draw the thread **straight upward** and under the tension spring as shown in Fig. 9, until the bobbin begins to unwind.

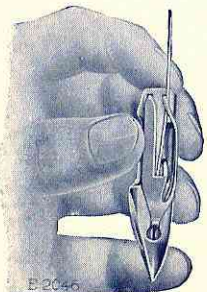

FIG. 9

To Replace the Shuttle

After threading, take the shuttle in the right hand with the point toward you and the tension adjusting

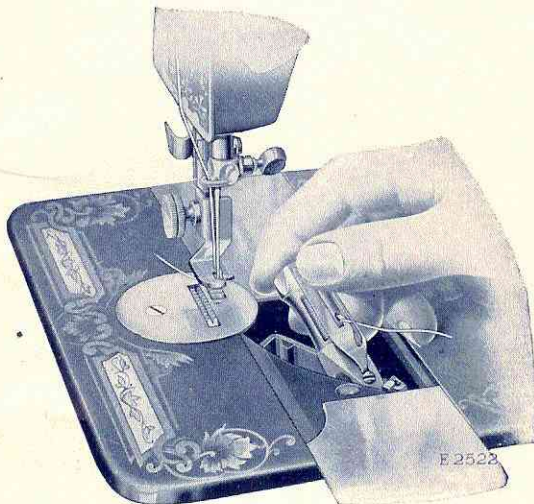

FIG. 10. REPLACING THE SHUTTLE

screw (1, Fig. 7, page 8) upwards. Put the point of the shuttle into the front end of the shuttle carrier as shown in Fig. 10, and drop the shuttle into place, leaving a loose end of thread about three inches long above the slide. When closing the slide, leave just enough space for the thread to pass through

To Set the Needle

Turn the balance wheel over toward you until the needle bar (E, Fig. 5, page 6) moves up to its highest point, loosen the thumb screw (C, Fig. 5) in the needle clamp (B, Fig. 5) and put the needle up into the clamp as far as it will go, with its flat side toward the right, then tighten the thumb screw. To select the correct needle see page 33.

To Thread the Needle

SEE FIG. 11 ON THE FOLLOWING PAGE

Turn the balance wheel over toward you until the thread take-up lever (4) is raised to its highest point. Place the spool of thread on the spool pin at the top of the machine, lead the thread into the thread guide (1) at the top of the face plate, down, under and from right to left between the tension discs (2), into the small wire spring (3) at the left of the tension discs, up and from front to back through the hole in the end of the thread take-up lever (4), down into the eyelet (5) in front of the face plate, into the lower wire guide (6) then from left to right through the eye of the needle (7).

Draw about two inches of thread through the eye of the needle with which to commence sewing

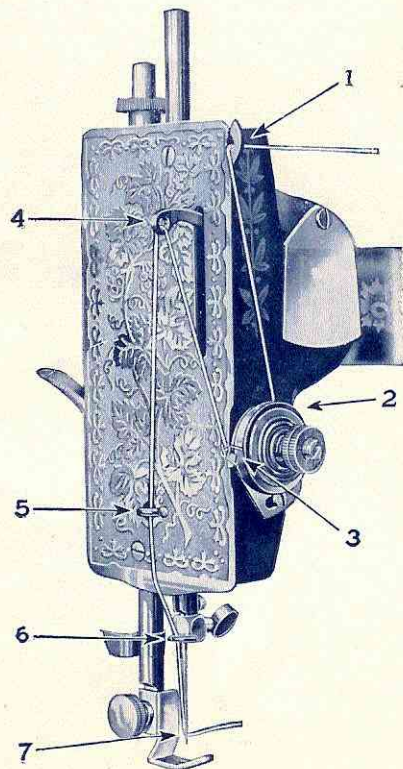

FIG. 11. THREADING THE NEEDLE

To Prepare for Sewing

With the left hand hold the end of the needle thread, leaving it slack from the hand to the needle.

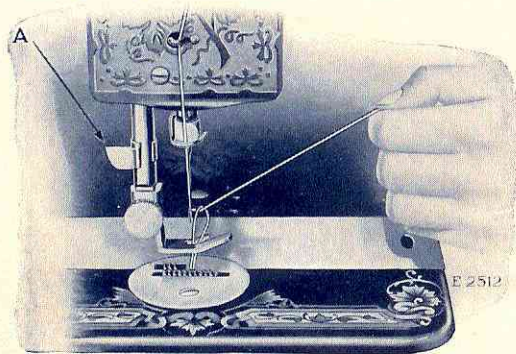

FIG. 12. DRAWING UP THE BOBBIN THREAD

Turn the balance wheel over toward you until the needle moves down and up again to its highest point, thus catching the bobbin thread, draw up the needle thread and the bobbin thread will come up with it through the hole in the throat plate (see Fig. 12). Lay both threads back under the presser foot and close the slides.

To Commence Sewing

Place the material beneath the presser foot, lower the presser foot and commence to sew, turning the balance wheel over toward you.

To Remove the Work

Let the thread take-up lever rest at its highest point, raise the presser foot and draw the fabric back and to the left, pass the threads over the thread cutter (A, Fig. 12) and pull down lightly to sever them. Leave the ends of the threads under the presser foot.

Tensions

For ordinary stitching the needle and the bobbin threads should be locked in the centre of the thickness of the material, thus:



FIG. 13. PERFECT STITCH

If the tension on the needle thread is too tight, or if that on the bobbin thread is too loose, the needle thread will lie straight along the upper surface of the material, thus:



FIG. 14. TIGHT NEEDLE THREAD TENSION

If the tension on the bobbin thread is too tight, or if that on the needle thread is too loose, the bobbin thread will lie straight along the under side of the material, thus:



FIG. 15. LOOSE NEEDLE THREAD TENSION

To Regulate the Tensions

The tension on the needle thread should only be regulated when the presser foot is down. Having lowered the presser foot, turn the small thumb nut (D, Fig. 5, page 6) at the front of the tension discs over to the right to increase the tension. To decrease the tension, turn the thumb nut over to the left.

The tension on the bobbin thread is regulated by the small screw (1, Fig. 7, page 8) near the point of the shuttle. To increase the tension, turn the screw over to the right. To decrease the tension, turn the screw over to the left.

When the tension on the bobbin thread has been once properly adjusted, it is seldom necessary to change it, as a correct stitch can usually be obtained by varying the tension on the needle thread.

To Turn a Corner

Stop the machine with the needle at its lowest point. Raise the presser foot and turn the work as desired, using the needle as a pivot.

To Regulate the Length of Stitch

The length of stitch is regulated by the large thumb screw (E, Fig. 6, page 7) on the front of the arm near the bobbin winder.

To lengthen the stitch, turn this screw over to the right. To shorten the stitch, turn this screw over to the left.

To Regulate the Pressure on the Material

For ordinary family sewing it is seldom necessary to change the pressure on the material. If sewing fine silk or flimsy material, lighten the pressure by turning the thumb screw (A, Fig. 5, page 6) on the top of the machine over to the left. To increase the pressure, turn the screw over to the right. The pressure should be only heavy enough to prevent the material from rising with the needle and to enable the feed to move the work along evenly; a heavier pressure will make the machine run hard.

To Sew Flannel or Bias Seams

Use a short stitch and as light a tension as possible on the needle thread so as to leave the thread loose enough in the seam to allow the goods to stretch if necessary.

A Stitch to Ravel Easily

can be made if desired, by having the tension on the needle thread so light that the bobbin thread will not draw into the goods but lie straight, as shown in Fig. 15, page 13

HINTS

The Belt. See that the belt is not too tight; it should always be tight enough not to slip. If too loose remove the hook at one end, shorten the belt and rejoin.

Machine Working Heavily. If the machine runs hard after standing idle for some time use a little kerosene in the oiling places, run the machine rapidly, then wipe clean and oil.

To Avoid Breaking Needles. See that the presser foot or attachments are securely fastened by the thumb screw. Do not sew heavy seams or very thick goods with too fine a needle. A large needle and thread to correspond should be used on heavy work (see page 33).

See that the needle is not bent and avoid pulling the material when stitching.

Breaking of Needle Thread. If the needle thread breaks it may be caused by:

Improper threading.

Tension being too tight.

The thread being too coarse for size of needle.

The needle being bent, having a blunt point, or being set incorrectly.

Breaking of Bobbin Thread. If the bobbin thread breaks it may be caused by:

Improper threading of the shuttle.

Tension being too tight.

Skipping of Stitches. The needle may not be accurately set into the needle bar or the needle may be blunt or bent. The needle may be too small for the thread in use.

To Oil the Machine

To ensure easy running, the machine requires oiling and if used continuously it should be oiled

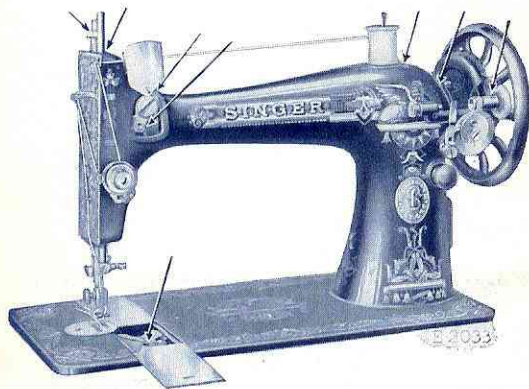

FIG. 16. OILING POINTS AT THE FRONT OF THE MACHINE

each day. With moderate use an occasional oiling is sufficient. Oil should be applied at each of the places shown by arrows in Figs. 16 and 17. One drop of oil at each point is sufficient. Oil holes are provided in the machine for bearings which cannot be directly reached.

To oil the mechanism under the slide, draw the front slide (see Fig. 16) toward you and after removing the lint and dust which may have accumulated, put a few drops of oil on the wick which is retained in the hole in the bed of the machine. The slide should then be closed.

On the front of the machine at the left is a small plate or cover (see Fig. 16) fastened by a screw; loosen the screw, turn the plate upward and fasten by tightening the screw; turn the balance wheel

slowly and oil the movable parts inside, then turn the cover down and fasten it as before.

On the back of the arm is a round plate or cover, fastened by a thumb screw, loosen the screw, turn the plate upward and fasten by tightening the screw, turn the balance wheel slowly and oil the moving parts inside, then turn the cover down and fasten it as before.

To reach the parts underneath the bed, the belt must be thrown off the band wheel on the machine stand. For this purpose a belt shifter (F, Fig. 1, page 1) is placed at the front of the band wheel. By pressing the belt shifter lever to the left and

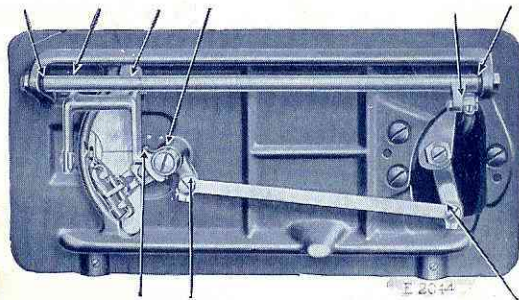

FIG. 17. OILING POINTS IN BASE OF MACHINE

working the treadle meanwhile, the belt is released and the machine can then be turned back on its hinges. The places to be oiled are indicated in Fig. 17, by arrows pointing to the oil holes and bearings.

To oil the stand, put a drop of oil on the centres on which the band wheel and treadle work, and both ends of the pitman rod which connects the treadle with the band wheel.

INSTRUCTIONS FOR USING THE ATTACHMENTS

FOOT HEMMER—Hemming

Raise the needle to its highest point. Remove the presser foot and attach the foot hemmer in its

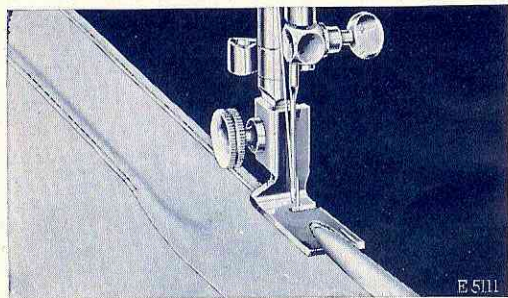

Fig. 18

place (see Fig. 18). Clip off the right hand corner of the cloth, so that it will take the roll easily, turn up the edge about a quarter of an inch, insert it in the mouth of the hemmer and draw or push it along until under the needle. Then let down the presser bar and after taking two or three stitches, draw gently on the ends of the threads to help the work along till the feed catches it. In order to produce a smooth even hem, the mouth of the hemmer must be kept just full

Fig. 18 shows also what is known as a bag seam or fell, made by passing two pieces of fabric through the hemmer together and hemming them down.

FOOT HEMMER—Hemming and Sewing on Lace

Start the hem as previously explained, and when it is well started, raise the needle to its highest point.

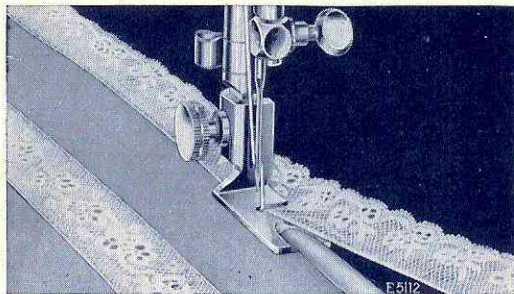

Fig. 19

Raise the hemmer to relieve its pressure on the hem, pass the end of the lace through the slot in the side of the hemmer, under the back of the hemmer and over the hem, as shown in Fig. 19.

Take care that the hem is not displaced in the hemmer and that the needle goes down through the lace and hem together. Then let down the presser bar and guide the lace over the front of the hemmer, keeping it well into the slot.

FOOT HEMMER—Felling

The two pieces of cloth to be felled should be laid one over the other, right sides together, the edge of the under piece being a little farther to the right

than the upper piece. Stitch them together, using the hemmer as a presser foot, the front end of the

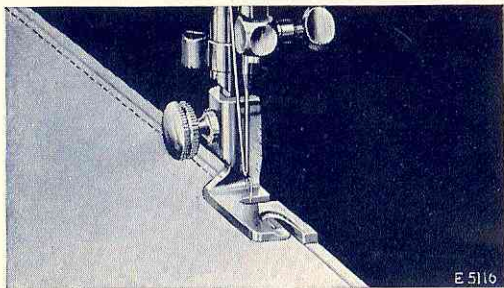

FIG. 20

hemmer forming a guide for the edges of both pieces, the upper piece being guided by the inside and the

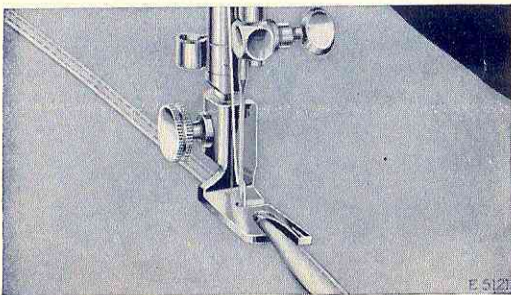

FIG. 21

under piece by the outside of the projecting front of the foot hemmer (see Fig. 20). Then open the work out flat, wrong side up, the edges standing up

straight, and taking the edges near the beginning of the seam in the right hand, and the ends of the threads in the left hand, draw the edges into the hemmer which will turn them as in hemming. Guide the second row of stitching by following the first row with the inside of the projecting front of the foot hemmer (see Fig. 21, page 20).

ADJUSTABLE HEMMER—Hemming

Remove the presser foot and attach the adjustable hemmer in its place as shown in Fig. 22. This

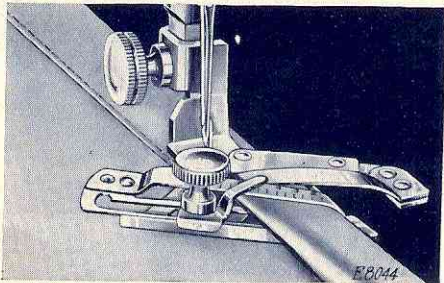

FIG. 22

hemmer will turn hems from $\frac{3}{16}$ inch to $\frac{15}{16}$ in. wide. The adjustment is made by loosening the thumb screw on the hemmer and moving the scale to the right or left until the hem turned is of the desired width. Place the cloth under the hemmer and draw the edge toward the left under the scale, as shown in Fig. 22. Draw the edge of the cloth back and forth until the hem is formed, stopping with the end under the needle. Lower the presser bar and commence to sew, being careful to so guide cloth as to keep hemmer full.

ADJUSTABLE HEMMER—Wide Hemming

To make a hem more than $\frac{1}{2}$ inch wide, loosen the thumb screw in the hemmer and move the scale

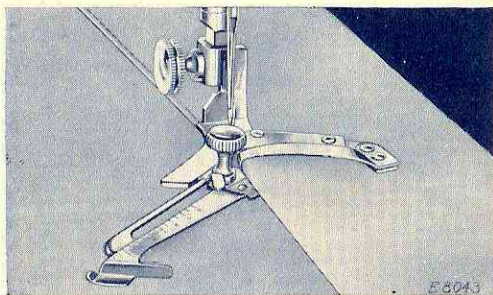

FIG. 23

to the right as far as it will go, then swing it toward you as shown in Fig. 23, and tighten the thumb screw. Fold and crease down a hem of the desired width; pass the fold under the extension at the right of the hemmer, and the edge into the folder as shown in Fig. 23, and proceed to stitch the hem.

BINDER—Binding

Remove the presser foot and attach the binder in its place. Pass the binding through the scroll of the binder and draw it back under the needle. Place the edge of the goods to be bound between the scrolls of the binder and draw it under the needle. Lower the presser bar and sew as usual. To make French folds proceed as directed for binding except that the fold is stitched on to the face of the material

instead of on the edge (see Fig. 24). After loosening the binder set screw and adjusting the binder the

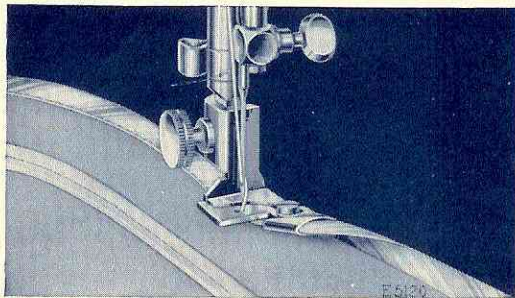

FIG. 24

line of stitching can be brought nearer the centre, this being more effective when making French folds.

TUCKER

Remove the presser foot and attach the tucker in its place. The width of the tuck is determined by the scale of figures nearest the needle, which shows in eighths and sixteenths of an inch the distance of the edge of the fold from the line of stitching.

The crease or mark for the second and following tucks is determined by the scale nearest the operator and this is set by the line in front of the needle hole in the presser foot. For blind tucks without spaces, adjust the scale nearest the operator so that the figure opposite the line on the presser foot will be the same as that at which the guide is located on the scale nearest the needle. To make spaces between the tucks, move the front scale farther to the left until the desired space is obtained.

Having adjusted the scales for tuck and space as desired, fold the material and crease by hand; pass

the folded edge between the spring and spur near you, then between the two blades of the second

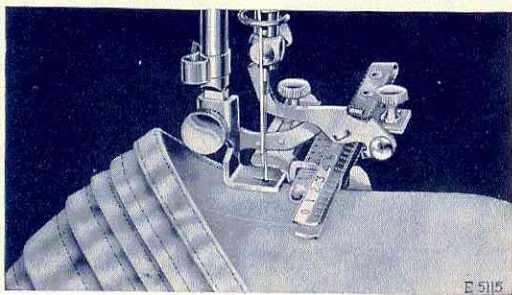

FIG. 25

scale, and back under the presser foot; draw to the right against the guide, lower the presser bar; see that the lever for the needle clamp to strike is in its backward position so as to form a crease for the next tuck, then proceed with the first tuck.

For the second tuck, fold carefully at the crease made by the spur and place the edge of the first tuck underneath and against the spur at the left. The spur will serve as a guide and will also make a distinct crease for the next tuck. Always place the last tuck against the spur to ensure perfect work.

When making the last tuck, the lever upon which the needle clamp strikes while tucking should be raised to its highest point; while the lever is in this position no crease for a succeeding tuck is made

Ruffler

Lines 1, 2, 3, 4 and 5 shown in Fig. 26 indicate where the material is to be placed for various operations, as follows:

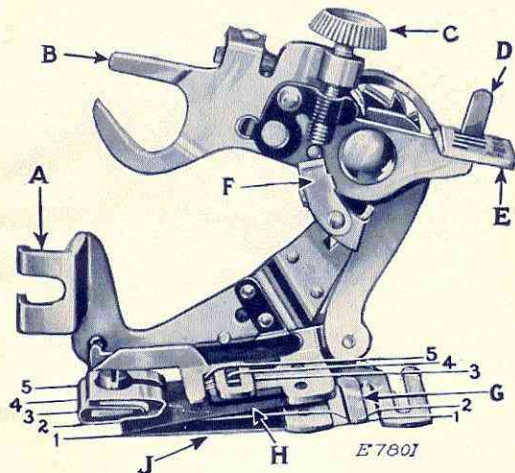

FIG. 26. THE RUFFLER AND ITS PARTS

- Line 1**—the correct position for the material to which the ruffled material is applied.
- Line 2**—material to be ruffled.
- Line 3**—the facing for the ruffle.
- Line 4**—the strip of piping material.
- Line 5**—the edge to be piped.

The names and uses of the principal parts of the ruffler are as follows:

(SEE REFERENCES IN FIG. 26)

- A—FOOT—the part by which the ruffler is attached to the presser bar.
- B—FORK ARM—the section that must be placed astride the needle clamp.
- C—ADJUSTING SCREW—the screw that regulates the fullness of the gather.
- D—PROJECTION—the part that projects through the slots in the adjusting lever.
- E—ADJUSTING LEVER—the lever that sets the ruffler for gathering or for making a plait once at every six stitches or once at every twelve stitches, as desired; also for disengaging the ruffler, when either plaiting or gathering is not desired.
- F—ADJUSTING FINGER—the part which regulates the width or size of the plaits.
- G—SEPARATOR GUIDE—the guide on the underside of the ruffler, containing slots into which the edge of the material is placed to keep the heading of the ruffle even; also for separating the material to be ruffled from the material to which the ruffle is to be attached.
- H—RUFFLING BLADE—the upper blue steel blade with the teeth at the end to push the material in plaits up to the needle.
- J—SEPARATOR BLADE—the lower blue steel blade without teeth, which prevents the teeth of the ruffling blade coming into contact with the feed of the machine, or the material to which ruffle or plaiting is to be applied.

To Attach the Ruffler to the Machine

Raise the needle bar to its highest point and remove the presser foot. Attach the ruffler foot (A, Fig. 26) to the presser bar by means of the thumb screw, at the same time placing the fork arm (B, Fig. 26) astride the needle clamp as shown in Fig. 27.

To Adjust the Ruffler for Gathering

The adjusting finger (F, Fig. 27) is not intended for gathering and should be moved forward or away from the needle, as shown in Fig. 27

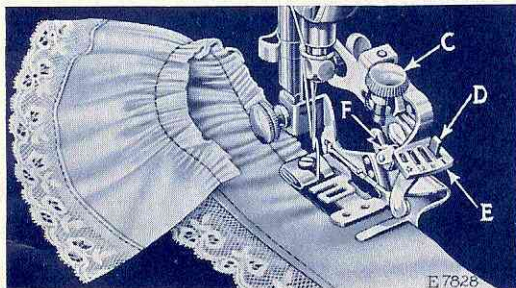

FIG. 27

Raise the adjusting lever (E, Fig. 27) and move it to the left so that the projection (D, Fig. 27) will enter the slot marked "1" in the adjusting lever (E) when the lever is released. The ruffling blade will then move forward and back once at every stitch. Insert the material to be ruffled between the two blue blades, following the line 2 in Fig. 26. Draw the material slightly back of the needle, lower the presser bar and commence to sew.

To make fine gathering, shorten the stroke of the ruffling blade by turning the adjusting screw (C, Fig. 27) upwardly, also shorten the stitch. To make full gathering, lengthen the stroke of the ruffling blade by turning the adjusting screw (C) downwardly, also lengthen the stitch. By varying these adjustments, many pleasing varieties of work can be accomplished.

To Make a Ruffle and Sew it to a Garment in One Operation

Insert the material to be ruffled between the two blue blades, as shown in Fig. 28, following the line

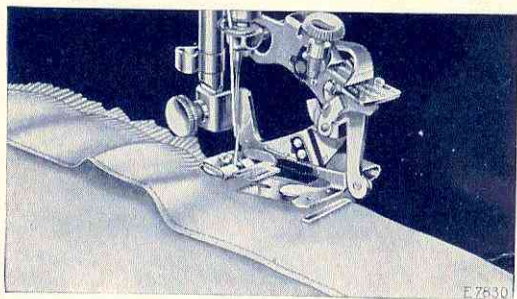

FIG. 28

2, in Fig. 26. Place the garment to which the ruffle is to be attached, under the separator blade, following the line 1, in Fig. 26. Proceed the same as for gathering.

The edge of the ruffled seam can be bound by using the bunder.

To Ruffle and Sew on a Facing in One Operation

Insert the material to be ruffled between the two blue blades, following the line 2, in Fig. 26. Place the garment to which the ruffle is to be attached, under the separator blade, following the line 1, in Fig. 26. Place the material for the facing over the upper blue blade, as shown in Fig. 29, following the line 3, in Fig. 26. The facing may be straight

the ruffle so that the wrong sides are together. If the facing is to be on the wrong side, place the right sides of the garment and the ruffle together.

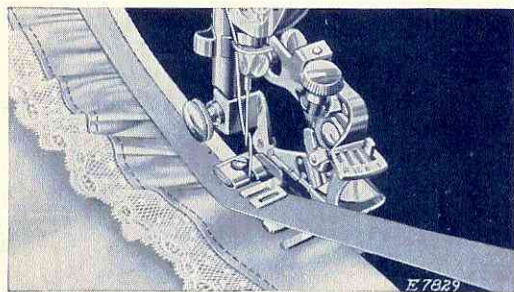

FIG. 29

Piping a Ruffle

Insert the material to be ruffled between the two blue blades, following the line 2, in Fig. 26. This

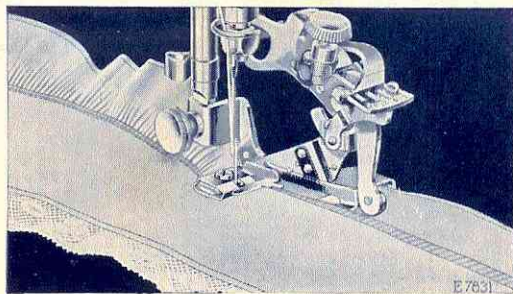

FIG. 30

edge of the ruffle to the right of the attachment as shown in Fig. 30.

The material for piping must measure about $\frac{1}{4}$ inch wide when folded in the centre and is usually cut on the bias. Place the piping material in the ruffler, following the line 4, in Fig. 26, with the folded edge of the piping to the right. The material to which the piping and ruffling are to be sewn should be folded on the edge and inserted in the ruffler, following the line 5, in Fig. 26.

To Adjust the Ruffler for Plaiting

Raise the adjusting lever (E, Fig. 31) and move it to the right so that the projection (D, Fig. 31)

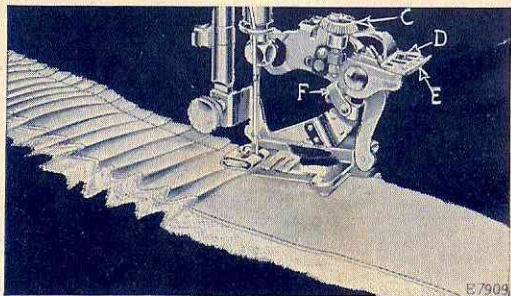

Fig. 31

will enter the slot marked "6" in the adjusting lever when the lever is released. The ruffling blade will then move forward and back once at every six stitches. To adjust the ruffling blade to make a plait once at every twelve stitches, place the adjusting lever (E, Fig. 31) so that the projection (D) enters the slot marked "12" in the adjusting lever. Insert the material to be plaited between the two blue blades, following the line 2, (Fig. 26). The size or width of plaits is regulated by the adjusting screw

(C, Fig. 31) and the adjusting finger (F, Fig. 31). To make a wider plait, move the adjusting finger (F) back or toward the needle and turn the adjusting screw (C) downwardly. To make a smaller plait, turn the adjusting screw (C) upwardly. The distance between plaits is regulated by the length of stitch.

To Adjust the Ruffler for Group Plaiting and Gathering

The ruffler can be adjusted for group plaiting by lifting the adjusting lever (E, Fig. 32) and moving

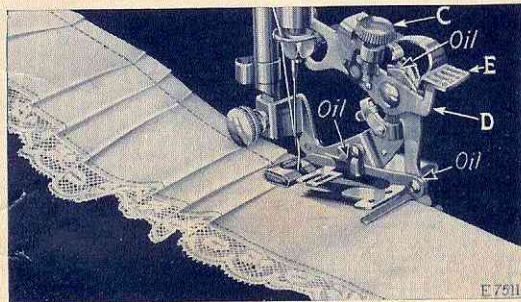

Fig. 32

it to the right so that the top of the projection (D, Fig. 32) engages the small slot indicated by the star on the adjusting lever. This should be done at the points where you wish to make the space between the plaits. The ruffler will then stop and plain stitching will be made. When the desired space has been made, adjust the lever (E) so that the projection (D) enters either the slot marked "6" or the slot marked "12." By alternately making groups of plaits and plain spaces, as shown in Fig. 32, very attractive work can be produced.

To Oil the Ruffler

Occasionally apply a drop of oil to the working parts of the ruffler at each of the places indicated by arrows in Fig. 32. After oiling, operate the ruffler on a waste piece of material to prevent the oil soiling the work. If the ruffler does not plait evenly, a drop of oil may remedy the trouble.

**Genuine Singer Needles should be used
in Singer Machines.**

**These Needles and their Containers
are marked with the
Company's Trade Mark "SIMANCO." 1**

Needles in Containers marked

"For Singer Machines"

are not Singer made needles. 2